

Climate 5000i M

CL3000iU W 20 E

bg	Климатик мулти сплит	Ръководство за обслужване за потребителя	2
cs	Multifunkční splitová klimatizační jednotka	Návod k obsluze	11
da	Multi-Split-klimaapparat	Betjeningsvejledning til ejeren	20
de	Multi-Split-Klimagerät	Bedienungsanleitung für den Betreiber	29
el	Κλιματιστικό τύπου Multi-Split	Οδηγίες χρήσης για τον υπεύθυνο λειτουργίας	38
en	Multi-Split air conditioner	Operating instructions for users	47
es	Climatizador Multi-Split	Manual de servicio para el usuario	56
et	Multi-split-kliimaseade	Kasutusjuhend seadme käitajale	65
fr	Climatiseur Multisplit	Notice d'utilisation destinée à l'exploitant	74
hr	Multi split klima-uređaj	Upute za uporabu za korisnika	83
hu	Multi-split klímakészülék	Kezelési útmutató az üzemeltető számára	92
it	Condizionatore multisplit	Istruzioni per l'uso per il gestore	101
lt	"Multi-Split" kondicionierius	Naudotojui skirta naudojimo instrukcija	110
lv	"Multi-Split" gaisa kondicionēšanas iekārta	Lietošanas instrukcija lietotājam	119
mk	Мулти-сплит клима уред	Упатства за ракување за корисникот	128
nl	Multi-Split-airconditioning	Handleiding voor de gebruiker	136
pl	Urządzenie klimatyzacyjne Multi Split	Instrukcja obsługi dla użytkownika	145
pt	Ar condicionado Multi-Split	Manual de instruções para o operador	154
ro	Aparat de aer condiționat tip multi-split	Instrucțiuni de utilizare destinate utilizatorului	163
sk	Multifunkčné splitové klimatizačné zariadenie	Návod na obsluhu pre prevádzkovateľa	172
sl	Multi Split klimatska naprava	Navodila za uporabo	181
sq	Kondicioner Multi Split	Manuali i përdorimit	190
sr/ cnr	Multi-split klima-uređaj	Uputstvo za upotrebu za korisnika	198
tr	Multi Split Klima	Kullanım Kılavuzu	206
uk	Багатозональна спліт-система кондиціонування	Інструкція з експлуатації для користувача	214

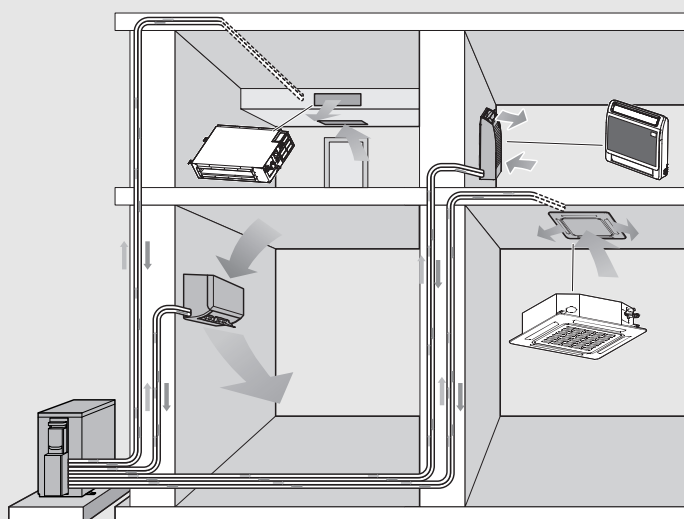

Table of contents

1 Explanation of symbols and safety instructions 47

1.1 Explanation of symbols 47

1.2 General safety instructions 48

1.3 Notices regarding these instructions. 48

2 Product Information..... 49

2.1 Declaration of conformity 49

2.2 Specifications of remote control 49

3 Operation..... 49

3.1 Indoor unit overview..... 49

3.2 Remote control overview 49

3.3 Using the remote control 50

3.4 Setting main operating mode..... 50

3.5 Setting timer 51

3.6 Other functions..... 51

3.6.1 Setting the swing function 51

3.6.2 Changing over display and alarm buzzer (Mute Mode) 51

3.6.3 Turbo cool/Turbo heat 51

3.6.4 Frost protection (8 °C Heating) 51

3.6.5 Key lock function..... 52

3.6.6 Advanced operating functions..... 52

4 Troubleshooting 52

4.1 Faults with indication (Self diagnosis function) .. 52

4.2 Operating mode conflict 52

4.3 Faults not indicated 53

5 Maintenance 54

5.1 Replacing the batteries 54

5.2 Cleaning the unit and the remote control 54

5.3 Cleaning the air filter 54

5.4 Decommissioning for longer periods 54

6 Environmental protection and disposal 54

7 Data Protection Notice 55

1 Explanation of symbols and safety instructions

1.1 Explanation of symbols

Warnings

In warnings, signal words at the beginning of a warning are used to indicate the type and seriousness of the ensuing risk if measures for minimizing danger are not taken.

The following signal words are defined and can be used in this document:

 **DANGER**

DANGER indicates that severe or life-threatening personal injury will occur.

 **WARNING**

WARNING indicates that severe to life-threatening personal injury may occur.

 **CAUTION**

CAUTION indicates that minor to medium personal injury may occur.

NOTICE

NOTICE indicates that material damage may occur.

Important information

 The info symbol indicates important information where there is no risk to people or property.





Symbol	Meaning
	Warning regarding flammable substances: the refrigerant R32 used in this product is a gas with low combustibility and low toxicity (A2L or A2).
	Wear protective gloves during installation and maintenance work.
	Maintenance by a qualified person should be done while following the instructions of the service manual.
	For operation follow the instructions of the user manual.

Table 36

1.2 General safety instructions

⚠ Notices for the target group

These operating instructions are intended for the operator of the air conditioning system. All system-relevant instructions must be observed. Failure to comply with instructions may result in material damage and personal injury, including danger to life.

- ▶ Read and retain the operating instructions of all system components prior to use.
- ▶ Observe the safety instructions and warnings.

⚠ Intended use

The indoor unit is intended for installation inside the building with connection to an outdoor unit and further system components, e.g. controls.

The outdoor unit is intended for installation outside the building with connection to an indoor unit or units and further system components, e.g. controls.

The air conditioning system is intended for commercial/residential use only where temperature deviations from adjusted set points do not lead to damage of living beings or materials. The air conditioning system is not suitable to set and maintain desired absolute humidity levels precisely.

Any other use is considered inappropriate. Any damage that may result from misuse is excluded from liability.

For installation at special locations (underground garage, mechanical rooms, balcony or at any semi-open areas):

- ▶ First refer to the requirements for the installation site in the technical documentation.

⚠ General dangers posed by the refrigerant

- ▶ This appliance is filled with refrigerant. If the refrigerant gas gets into contact with fire, it may generate toxic gas.
- ▶ Have the system inspected and serviced regularly by an approved contractor.
- ▶ If there is a possibility that refrigerant has escaped, thoroughly ventilate the room and notify the approved contractor.

⚠ Conversion and repairs

If modifications to the air conditioning system are not carried out correctly, this can result in personal injury and/or material damage.

- ▶ Have work carried out only by an approved contractor.
- ▶ Do not make any changes to the outdoor unit, indoor unit or other parts of the air conditioning system.
- ▶ Disconnect the air conditioning system from the power supply before carrying out any maintenance work.

⚠ Notices on handling the system

If the air conditioning system is used incorrectly, this could impair your health.

- ▶ Do not stand directly in the airflow for any length of time.
- ▶ Ensure that the room temperature is suitable for all people in the room, including babies, children, elderly, bedridden or disabled people.
- ▶ Never insert objects into the unit, you could injure yourself.

If the unit is handled incorrectly, this can lead to reduced performance and also damage to the unit and personal injury.

- ▶ Do not block the air inlets and outlets of the unit.
- ▶ Shut doors and windows when the unit is in operation.
- ▶ Protect the indoor unit from water ingress.
- ▶ Check the outdoor unit mounting rack periodically for wear and to make sure it is firmly in place.
- ▶ Do not apply any weight to the outdoor unit, e.g. objects or persons.
- ▶ Keep dust, steam and moisture in the installation room of the indoor unit to a minimum.
- ▶ Do not use highly-flammable gases, e.g. from spray cans, in the vicinity of the units.
- ▶ If there appears to be something wrong with the air conditioner (burning smell or faulty cable for example), stop using it immediately and disconnect the power supply.

⚠ Safety of electrical devices for domestic use and similar purposes

The following requirements apply in accordance with EN 60335-1 in order to prevent hazards from occurring when using electrical appliances:

“This appliance can be used by children of 8 years and older, as well as by people with reduced physical, sensory or mental capabilities or lacking in experience and knowledge, if they are supervised and have been given instruction in the safe use of the appliance and understand the resulting dangers. Children shall not play with the appliance. Cleaning and user maintenance must not be performed by children without supervision.”

“If the power cable is damaged, it must be replaced by the manufacturer, its customer service department or a similarly qualified person, so that risks are avoided.”

1.3 Notices regarding these instructions

The figures are shown together at the end of these instructions. The text contains references to the figures.

Depending on the model, the products may be different to those shown in these instructions.

2 Product Information

2.1 Declaration of conformity

The design and operating characteristics of this product comply with the European and national requirements.

CE The CE marking declares that the product complies with all the applicable EU legislation, which is stipulated by attaching this marking.

The complete text of the Declaration of Conformity is available on the Internet: www.bosch-industrial.co.uk.

2.2 Specifications of remote control

Power supply	2 AAA batteries
Signal range	8 m
Permissible ambient temperature	-5 °C ... 60 °C

Table 37

3 Operation

3.1 Indoor unit overview

Key to Fig. 1:

- [1] Top panel
- [2] Space for small filter
- [3] Air filter
- [4] Back of the display
- [5] Button for manual operation
- [6] Airflow panel

Display of indoor unit

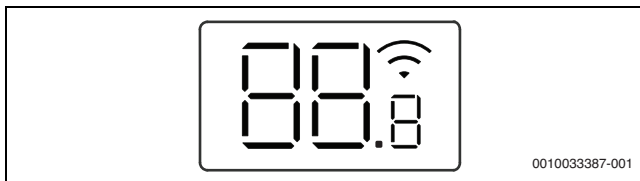

Symbol	Explanation
Number	Temperature display
	WLAN connection ¹⁾ active
	Displayed with some functions, if these are switched on. Indicates that the ON timer is active when the indoor unit is switched off.
OF	Displayed with some functions, if these are switched off.
dF	Automatic defrosting active
BP	Frost protection active: the indoor unit keeps the room temperature at at least 8 °C.
CL	The self-cleaning function is active (I clean)
Ex, Px, Fx	Fault code ("x" stands for any digit).

1) Only available as accessory with IP-Gateway.

Table 38 Symbols in the display

3.2 Remote control overview

Keys on remote control

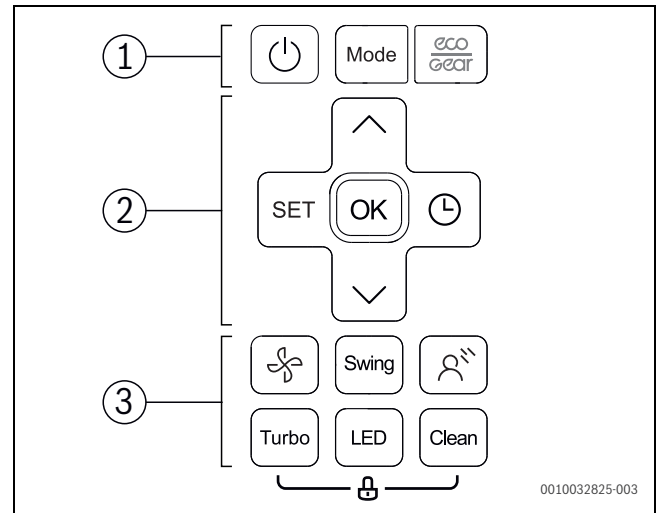

Pos.	Key	Function
1		Switch on/off.
	Mode	Set operating mode.
2	SET	Select advanced operating functions.
	OK	Confirm choice.
		Set timer.
		Increase temperature.
		Reduce temperature.
3		Fan step
	Swing	Set swing function.
	Turbo	Turbo cool/Turbo heat
	LED	Switch off display of indoor unit and alarm buzzer (Mute Mode).

Table 39 Keys on remote control

Display of remote control

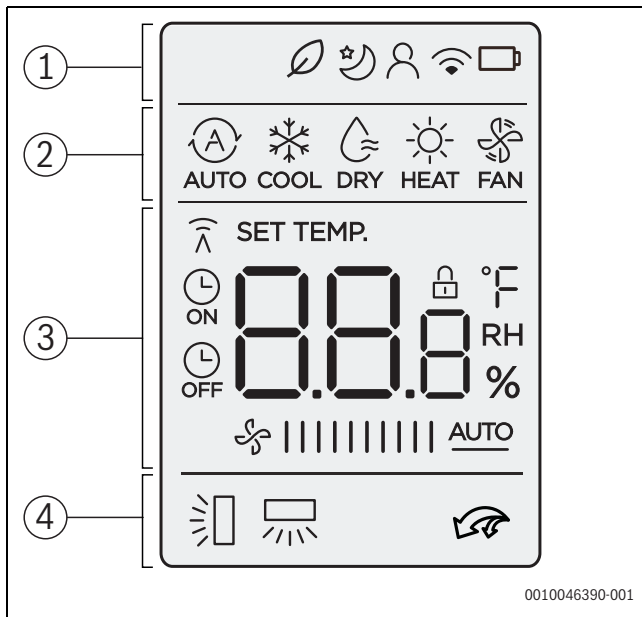

Pos.	Symbol	Explanation
		Without function.
		Operating function: setback mode is active.
1		Operating function: Follow Me function is active (Follow Me); temperature measurement at the remote control.
		Infographic: wireless control function.
		Infographic: battery status
		Operating mode: automatic mode
2		Operating mode: cooling mode
		Operating mode: dehumidification mode
		Operating mode: heating mode
		Operating mode: Fan Mode
		Value display: shows the set temperature, fan speed or (when timer is activated) the timer setting as standard.
3		Infographic: transmission indicator; lights up when the remote control sends a signal to the indoor unit.
		Infographic: ON/OFF timer active.
		Value display: shows the current fan speed. There are 10 different output stages and the setting AUTO for automatic control.
		Infographic: automatic vertical swing function active. (up/down).
4		Infographic: automatic vertical swing function active. (up/down).
		Infographic: Turbo cool/Turbo heat is active.

Table 40 Symbols in the display

3.3 Using the remote control

The signal range is 8 m. If objects are in the way or certain fluorescent lamps are used in the same room this can affect transmission of the signal.

- ▶ Point the remote control towards the signal receiver window of the device and press the desired key.
The device emits a beep when it receives a signal.

NOTICE

The remote control may be permanently prevented from working correctly.

- ▶ Do not expose the remote control to direct sunlight.
- ▶ Do not leave the remote control near a heating appliance.
- ▶ Protect the remote control from moisture and impacts.

3.4 Setting main operating mode

Switching on/off the unit

- ▶ Press the key to switch the unit on or off:
The unit starts in the set operating mode.

Settings can also be made when the unit is switched off. The unit saves the settings, and also retains them in the event of a power failure.



After turning off, the unit remains in standby mode. Intelligent on-off technology enables an automatic energy-saving mode when on standby mode (1 W standby).

Automatic mode

In automatic mode, the unit automatically switches between heating and cooling mode to maintain the desired temperature.

- ▶ Press **Mode** key repeatedly until appears on the display.
- ▶ Select the required temperature with the and keys.



The fan speed cannot be adjusted in automatic mode.

Cooling mode

- ▶ Press **Mode** key repeatedly until appears on the display.
- ▶ Press the key until the required air speed is reached.
- ▶ Select the required temperature with the and keys.

Fan (Only) mode

- ▶ Press **Mode** key repeatedly until appears on the display.
- ▶ Press the key until the required fan speed is reached. **AUTO** can be selected to enable automatic control.



The temperature cannot be adjusted or displayed in fan mode.



Dehumidification mode

- ▶ Press **Mode** key repeatedly until  appears on the display.
- ▶ Set the required temperature with the **^** and **v** keys.



The fan speed cannot be adjusted in dehumidification mode.

Heating mode

- ▶ Press **Mode** key repeatedly until  appears on the display.
- ▶ Set the required temperature with the **^** and **v** keys.
- ▶ Press the  key until the required fan speed is reached.





If the outside temperature is very low, the heating capacity of the air conditioning system may not be sufficient. We recommend connecting additional heat sources.



3.5 Setting timer

ON and OFF timers can be set to between 0 and 24 hours, in 30-minute increments for the first 10 hours, then in 1-hour increments. If 0 hours is set, the timer is cancelled.

Setting the on timer

- ▶ Press the  key until the  symbol appears.
- ▶ Press the **^** or **v** key to set the desired time.
The setting is applied shortly afterwards.

Setting the off timer

- ▶ Press the  key until the  symbol appears.
- ▶ Press the **^** or **v** key to set the desired time.
The setting is applied shortly afterwards.

Cancelling timer

- ▶ Press the  key to select the corresponding timer.
- ▶ Set 0.0 hours.
The timer is cancelled after a short time.

Combining timers

The two timers can be set at the same time. Either timer can be programmed to activate prior to the other

- ▶ Set the on timer and off timer.
The settings will be automatically combined.

Current time	13:00 o'clock
Setting of ON timer	4.0 h
Setting of OFF timer	8.5 h
Switch-on time	17:00 o'clock
Switch-off time	21:30 o'clock

Table 41 Example



You can not program the on timer and off timer to operate the unit at different temperatures or with other settings.

3.6 Other functions

3.6.1 Setting the swing function

NOTICE

If the louvre remains at the lowest position during cooling mode for an extended period, condensate may be discharged. Adjusting the louvres vertically by hand may cause faults.

- ▶ Only use the remote control to adjust the louvres vertically.

Swinging horizontally (left/right)

The horizontal position must be set by hand.

- ▶ Switch off the indoor unit and disconnect the power supply.
- ▶ Flip down the air baffle (→ Fig. 2).
- ▶ Swivel the louvres horizontally by hand into the required position.
- ▶ Put the air baffle back in the original position.

Automatic vertical Swing mode (up/down)

- ▶ Press the **Swing** key for longer than 2 seconds to activate the automatic vertical Swing mode.
The remote control displays the symbol .
- ▶ To cancel the automatic vertical Swing mode: press the **Swing** key again.

Cleaning position

To make cleaning easier, the louvre can be brought into a special position (depending on product type).

- ▶ Press the **Mode** and **Swing** keys simultaneously for one second when the device is switched off.
- ▶ To exit the cleaning position: press and hold both keys again.

3.6.2 Changing over display and alarm buzzer (Mute Mode)

- ▶ To switch on or off the display at the indoor unit and the alarm buzzer: press **LED** key.
- ▶ To display the current room temperature, press the **LED** key and hold for 5 seconds.
- ▶ To display the set temperature: press and hold the **LED** key for another 5 seconds.

3.6.3 Turbo cool/Turbo heat

When Turbo cool/Turbo heat is active, the indoor unit operates at maximum power to heat or cool the room quickly.

- ▶ Turbo cool: switch on Cooling mode and press the **Turbo** key.
- ▶ Turbo heat: switch on heating mode and press the **Turbo** key.

Exiting the function:

- ▶ Press the **Turbo** key again.

3.6.4 Frost protection (8 °C Heating)

The frost protection can be activated to keep the room temperature at a minimum of 8 °C.

- ▶ In heating mode, press the **v** key 2x within 1 second.
The unit remains off until the temperature falls below 8 °C.

Exiting the function:



- ▶ Press the  key, **Mode** key, **Turbo** key or **Clean** key.

3.6.5 Key lock function

The keys of the remote control can be locked with the keylock.

- ▶ To switch the keylock on/off: press the **Clean** and **Turbo** keys simultaneously for 5 seconds.
The symbol  appears in the display when the keylock is active.

3.6.6 Advanced operating functions

- ▶ Press the **Set** key.
- ▶ Press the **Set** key or **^**, **v** keys to select the function.
 -  = Sleep mode function
 -  = Follow me function
 -  = Wireless control function
- ▶ Confirm selection with the **OK** key.

Exiting the function:

- ▶ Repeat the above steps.

Sleep mode

The purpose of this function is to save energy during idle times. After an hour, the device heats or cools less intensely. To do this, the set temperature is changed by 1 °C. After two hours, the set temperature changes by a further 1 °C. Then it remains at the new temperature.



The function is not available in dehumidification mode and Fan Mode.

Follow me function (Follow Me)

The function activates the remote control at the current location in order to measure the temperature at 3- minute - intervals. The indoor unit is now controlled with reference to these measurements.



The Follow Me function is only available in cooling mode, heating mode and automatic mode.

Wireless control function

The purpose of this function is to establish a connection via WLAN. If the unit is not displaying the function, the **LED** key must be pressed quickly seven times in succession instead.



To connect to WLAN an IP-Gateway (accessory) must be installed.

4 Troubleshooting

4.1 Faults with indication (Self diagnosis function)

If a fault occurs during operation, the LEDs flash for an extended period or an error code is displayed (e.g. EH 02).

If a fault is present for more than 10 minutes:

- ▶ Briefly disconnect the power supply and switch the indoor unit back on.

If a fault persists:

- ▶ Call customer service and provide the fault code and details of the appliance.

4.2 Operating mode conflict

When using multi-split air conditioners, all operating modes are possible, but with the following special features:

If you operate more than one indoor unit, indoor units may go into standby due to an operating mode conflict. An operating mode conflict occurs when at least one indoor unit is in heating mode and at least one indoor unit is in another operation mode at the same time (e.g. cooling mode). Heating mode always has priority. All indoor units that are not in heating mode go into standby due to the operating mode conflict.



During operating mode conflict, the indoor unit shows "--" in the display.

Avoid the operating mode conflict:

- No indoor unit is in heating mode.
- All indoor units are in heating mode and/or off.

4.3 Faults not indicated

If faults occur during operation that cannot be eliminated:

- ▶ Call customer service about the fault, providing details of the device.

Fault	Possible cause
The output of the indoor unit is too low.	Temperature is set too high or too low.
	Air filter is soiled and must be cleaned.
	Unfavourable ambient conditions for the indoor unit, e.g. the ventilation openings of the devices are obstructed, doors/windows in the room are open or the room contains powerful heat sources.
	Low-noise operation is activated and prevents the full output from being used.
Indoor unit does not switch on.	The indoor unit has a safety mechanism to prevent overloading. It may take 3 minutes, until the indoor unit can be restarted.
	The batteries of the remote control are empty.
	The timer is switched on.
Operating mode changes from Cooling or Heating to Fan Mode.	The indoor unit changes operating mode to prevent the formation of frost.
	The set temperature is reached provisionally.
A white mist is coming from the indoor unit.	In humid regions, white mist may appear if there is a significant temperature difference between the indoor air and air-conditioned air.
White mist is emerging from the indoor unit and outdoor unit.	If heating mode is activated directly after automatic defrosting, this can generate white mist due to the higher level of humidity.
There is noise coming from the indoor unit and outdoor unit.	A swooshing noise may be heard inside the indoor unit if the position of the airflow grille is set back.
	A quiet hissing noise is normal during operation. This is caused by the flow of refrigerant.
	Creaks and squeaks may be heard, as the metal and plastic parts of the device expand or contract during heating/cooling.
	The outdoor unit also emits a range of other noises during operation which is normal.
Dust is being discharged from the indoor unit or outdoor unit.	Dust may accumulate in the devices if they are shut down for an extended period and not covered.
Unpleasant odour during operation.	Unpleasant odours in the air may enter the devices and spread.
	There may be mould on the air filter and it must therefore be cleaned.
The fan of the outdoor unit is not running continuously.	Variable fan control is used to ensure optimum operation.
Operation is irregular or unpredictable or the indoor unit is not responding.	The indoor unit may be affected by interference from mobile radio masts or external signal amplifiers. <ul style="list-style-type: none"> ▶ Briefly disconnect the indoor unit from the power supply then restart it.
Air baffle or louvres do not run correctly.	Air baffle or louvres have been adjusted manually or have not been correctly installed.
	▶ Switch off the indoor unit and check whether the components are engaged correctly.
	▶ Power on the IDU.

Table 42

5 Maintenance



CAUTION

Danger due to electric shock or moving parts

- ▶ Disconnect the power supply before carrying out any maintenance work.
- ▶ Have any maintenance steps that are not listed here carried out by an approved installer.

5.1 Replacing the batteries

You require 2 size AAA batteries. Using rechargeable batteries is not recommended.

- ▶ Remove the battery cover (→ Fig. 3).
- ▶ Insert new batteries, ensuring correct polarity.
- ▶ Reinstall the cover.

5.2 Cleaning the unit and the remote control

NOTICE

Damage to unit due to incorrect cleaning!

- ▶ Do not directly splash or pour water onto them.
- ▶ Do not use hot water, thinner, abrasive powders or strong solvents.
- ▶ Clean indoor unit and remote control by wiping them with a soft cloth.
- ▶ Only have the outdoor unit cleaned by an approved contractor.

5.3 Cleaning the air filter

NOTICE

The air filter may deform in direct sunlight.

- ▶ Do not expose the air filter to direct sunlight.

Clean the air filter every 2 weeks, and also before and after decommissioning for longer periods.

- ▶ Switch off the indoor unit.
- ▶ Fold the top cover of the indoor unit up.
- ▶ Push the air filter up and pull it out (→ Fig. 4).
- ▶ Take out the small air filters, if installed (→ Fig. 1, [2]).
- ▶ Clean the small air filters with a handheld vacuum cleaner.
- ▶ Wash the large air filter with warm water and a mild cleaning agent and dry in the shade.
- ▶ Reattach the small air filter and the large air filter.

5.4 Decommissioning for longer periods

Before decommissioning for longer periods:

- ▶ Clean the air filter.
- ▶ Activate the self-cleaning of the indoor unit using the **Clean** button.
- ▶ After self-cleaning, switch on the fan mode until the indoor unit is dry.
- ▶ Turn off indoor unit and disconnect power supply.
- ▶ Take batteries out of the remote control.
- ▶ Protect the devices from dust.

6 Environmental protection and disposal

Environmental protection is a fundamental corporate strategy of the Bosch Group.

The quality of our products, their economy and environmental safety are all of equal importance to us and all environmental protection legislation and regulations are strictly observed.

We use the best possible technology and materials for protecting the environment taking account of economic considerations.

Packaging

Where packaging is concerned, we participate in country-specific recycling processes that ensure optimum recycling.

All of our packaging materials are environmentally compatible and can be recycled.

Used appliances

Used appliances contain valuable materials that can be recycled.

The various assemblies can be easily dismantled. Synthetic materials are marked accordingly. Assemblies can therefore be sorted by composition and passed on for recycling or disposal.

Old electrical and electronic appliances



This symbol means that the product must not be disposed of with other waste, and instead must be taken to the waste collection points for treatment, collection, recycling and disposal.

The symbol is valid in countries where waste electrical and electronic equipment regulations apply, e.g. "European Directive 2012/19/EC on old electronic and electrical appliances". These regulations define the framework for the return and recycling of old electronic appliances that apply in each country.

As electronic devices may contain hazardous substances, it needs to be recycled responsibly in order to minimize any potential harm to the environment and human health. Furthermore, recycling of electronic scrap helps preserve natural resources.

For additional information on the environmentally compatible disposal of old electrical and electronic appliances, please contact the relevant local authorities, your household waste disposal service or the retailer where you purchased the product.

You can find more information here:

www.weee.bosch-thermotechnology.com/

Batteries

Batteries must not be disposed together with your household waste.

Used batteries must be disposed of in local collection systems.

Refrigerant R32



The appliance contains fluorinated gas R32 (global warming potential 675¹⁾) mild combustibility and low toxicity (A2L or A2).

Contained quantity is indicated on the equipment outdoor unit name label.

Refrigerant is hazardous to the environment and must be collected and disposed of separately.

1) Based on ANNEX I of REGULATION (EU) No 517/2014 of the European Parliament and of the Council of 16 April 2014.

7 Data Protection Notice



We, **Bosch Thermotechnology Ltd., Cotswold Way, Warndon, Worcester WR4 9SW, United Kingdom** process product and installation information, technical and connection data, communication data, product registration and client history data to provide product functionality (art. 6 (1) sentence 1 (b)

GDPR), to fulfil our duty of product surveillance and for product safety and security reasons (art. 6 (1) sentence 1 (f) GDPR), to safeguard our rights in connection with warranty and product registration questions (art. 6 (1) sentence 1 (f) GDPR) and to analyze the distribution of our products and to provide individualized information and offers related to the product (art. 6 (1) sentence 1 (f) GDPR). To provide services such as sales and marketing services, contract management, payment handling, programming, data hosting and hotline services we can commission and transfer data to external service providers and/or Bosch affiliated enterprises. In some cases, but only if appropriate data protection is ensured, personal data might be transferred to recipients located outside of the European Economic Area. Further information are provided on request. You can contact our Data Protection Officer under: Data Protection Officer, Information Security and Privacy (C/ISP), Robert Bosch GmbH, Postfach 30 02 20, 70442 Stuttgart, GERMANY.

You have the right to object, on grounds relating to your particular situation or where personal data are processed for direct marketing purposes, at any time to processing of your personal data which is based on art. 6 (1) sentence 1 (f) GDPR. To exercise your rights, please contact us via **privacy.ttg@bosch.com** To find further information, please follow the QR-Code.

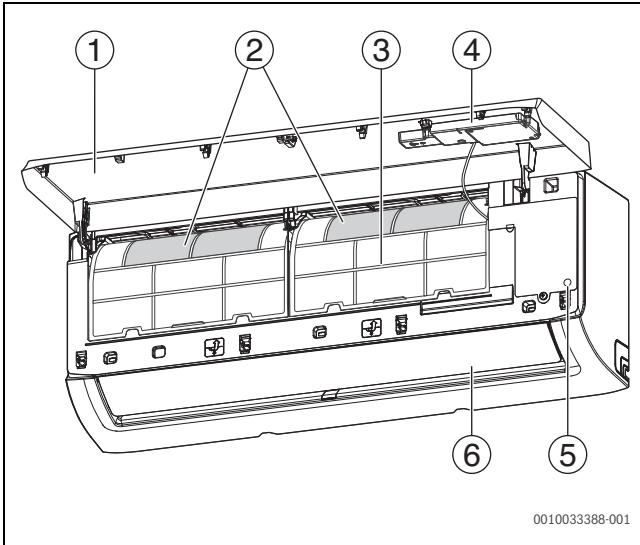

1

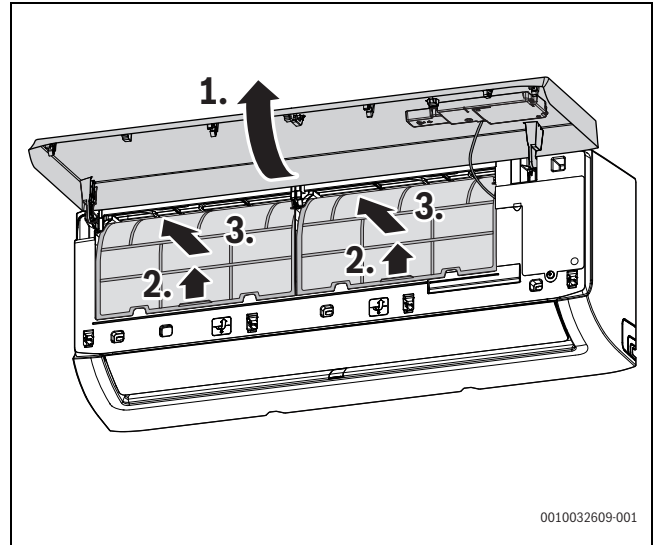

4

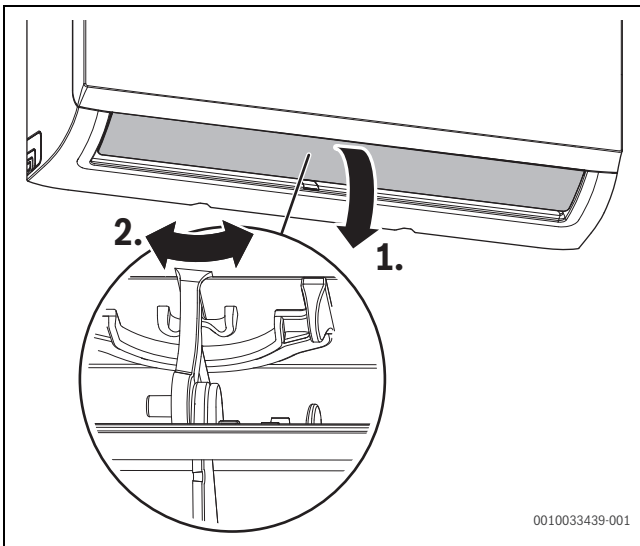

2

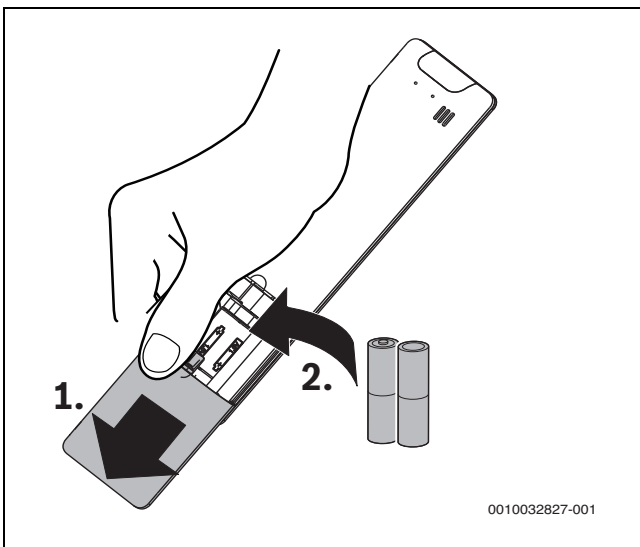

3

Bosch Thermotechnik GmbH
Junkersstrasse 20-24
D-73249 Wernau

www.bosch-thermotechnology.com

