



Operation Manual

Air to Water Heat Pump

**Compress 3400iAWS E**

Heat Pump with Indoor Unit

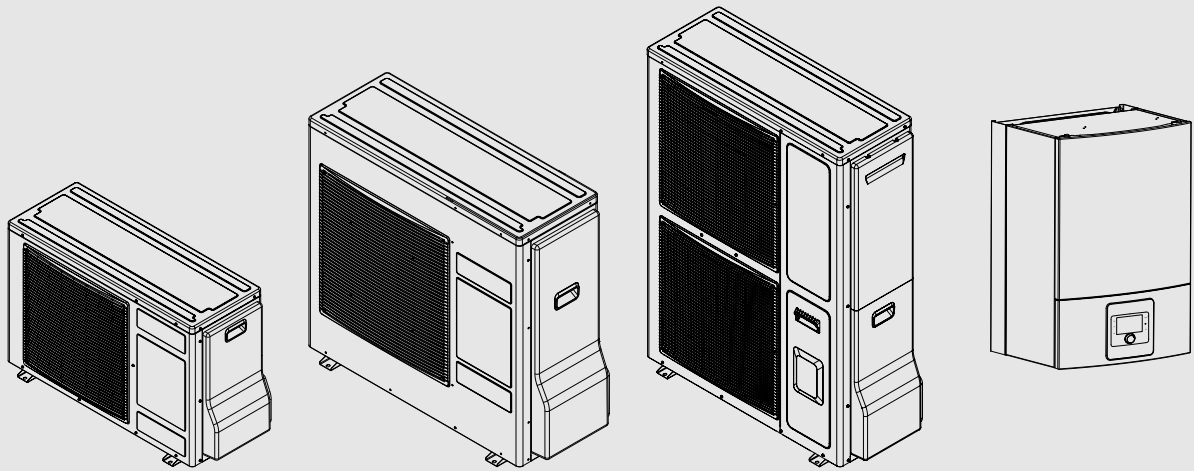

---

**Table of contents**

---

<b>1</b>	<b>Explanation of symbols and safety instructions</b> .....	<b>3</b>	4.2.4	Snow and ice .....	20
1.1	Explanation of symbols .....	3	4.3	Tightness test .....	20
1.2	General safety instructions .....	3	4.4	Information on refrigerant .....	21
1.2.1	Application area .....	3			
<b>2</b>	<b>Product description</b> .....	<b>4</b>	<b>5</b>	<b>Environmental protection and disposal</b> .....	<b>21</b>
2.1	Control unit .....	4	<b>6</b>	<b>Data Protection Notice</b> .....	<b>21</b>
2.2	Heat pump details .....	4	<b>7</b>	<b>Display of consumption values in relation to the funding guidelines for federal funding for efficient buildings - individual measures (BEG EM)</b> .....	<b>22</b>
2.3	Type plate .....	4	<b>8</b>	<b>Technical terms</b> .....	<b>22</b>
2.4	Declaration of Conformity .....	4	<b>9</b>	<b>Overview Main menu</b> .....	<b>23</b>
2.5	Heat pump (outdoor unit) .....	4	<b>10</b>	<b>Overview Info</b> .....	<b>24</b>
2.5.1	Generic overview of the refrigerant circuit .....	5			
2.6	Indoor unit .....	5			
2.7	Hints on energy saving .....	6			
<b>3</b>	<b>Operation</b> .....	<b>6</b>			
3.1	Control unit .....	6			
3.1.1	Operation after power failure .....	6			
3.1.2	Overview of control elements and symbols .....	6			
3.2	Control panel .....	7			
3.2.1	Switching off .....	8			
3.2.2	Selecting a heating circuit for the standard display .....	8			
3.2.3	Set operating mode .....	8			
3.2.4	Changing the room temperature temporarily .....	8			
3.2.5	Changing the room temperature permanently .....	8			
3.2.6	Adapting the heating system settings using the time program (automatic mode) .....	9			
3.2.7	Selecting active time program for the heating system .....	10			
3.2.8	Renaming a time program or heating circuit .....	10			
3.2.9	DHW settings .....	11			
3.2.10	Setting up a holiday program .....	11			
3.2.11	More settings .....	12			
3.3	Main menu .....	13			
3.3.1	Heating settings .....	13			
3.3.2	DHW settings .....	13			
3.3.3	Settings for the venting function .....	15			
3.3.4	Setting up a holiday program .....	16			
3.3.5	General Settings .....	16			
3.3.6	Settings for other systems or devices .....	17			
3.4	Calling up information about the system .....	17			
3.5	Faults .....	18			
3.6	Connect-Key K 30 RF .....	18			
<b>4</b>	<b>Maintenance</b> .....	<b>19</b>			
4.1	Indoor unit .....	19			
4.1.1	Checking the operating pressure .....	19			
4.1.2	Overheating protection .....	19			
4.1.3	Particle filter .....	19			
4.1.4	Moisture in cooling mode .....	20			
4.1.5	Checking the safety valves .....	20			
4.2	Heat pump (outdoor unit) .....	20			
4.2.1	Removing dirt and leaves .....	20			
4.2.2	Casing .....	20			
4.2.3	Evaporator .....	20			

# 1 Explanation of symbols and safety instructions

## 1.1 Explanation of symbols

### Warnings

In warnings, signal words at the beginning of a warning are used to indicate the type and seriousness of the ensuing risk if measures for minimizing danger are not taken.

The following signal words are defined and can be used in this document:

 **DANGER**  
**DANGER** indicates that severe or life-threatening personal injury will occur.

 **WARNING**  
**WARNING** indicates that severe to life-threatening personal injury may occur.

 **CAUTION**  
**CAUTION** indicates that minor to medium personal injury may occur.

**NOTICE**  
**NOTICE** indicates that material damage may occur.

### Important information

  
 The info symbol indicates important information where there is no risk to people or property.

### Additional symbols





Symbol	Meaning
	a step in an action sequence
	a reference to a related part in the document
	a list entry
	a list entry (second level)

Table 1





Symbol	Meaning
	Warning of low burning velocity material. The appliances CS3400iAWS 4-10 OR-S has R32 refrigerant which is a flammable refrigerant with low burning velocity (A2L). If the refrigerant is leaked and exposed to an external ignition source, there is a risk of fire.
	Warning of strong magnetic field.
	Maintenance by a qualified person should be done while following the instructions of the service manual.
	For operation follow the instructions of the user manual.

Table 2

## 1.2 General safety instructions

### 1.2.1 Application area

The heat pump may only be used in sealed heating systems according to EN 12828.

Other uses are not appropriate. Any damage that results from such use is excluded from liability.

The heat pump must undergo maintenance according to EN1717 4.6.

#### Notices for the target group

These operating instructions are intended for the heating system operator.

All instructions must be observed. Failure to comply with instructions may result in material damage and personal injury, including danger to life.

- ▶ Read and retain the operating instructions (heat generator, heating controller, etc.) prior to operation.
- ▶ Observe the safety instructions and warnings.
- ▶ Operate the heat generator only with the casing fitted and closed.

#### Safety of electrical appliances for domestic use and similar purposes

The following requirements apply in accordance with EN 60335-1 in order to prevent hazards from occurring when using electrical appliances:

”This appliance can be used by children of 8 years and older, as well as by people with reduced physical, sensory or mental capabilities or lacking in experience and knowledge, if they are supervised and have been given instruction in the safe use of the appliance and understand the resulting dangers. Children must not play with the appliance. Cleaning and user maintenance must not be performed by children without supervision.”

”If the power cable is damaged, it must be replaced by the manufacturer, its customer service department or a similarly qualified person, so that risks are avoided.”

#### Inspection and maintenance

Regular inspection and maintenance are prerequisites for safe and energy efficient operation of the heating system.

We recommend you enter into a contract for the annual inspection and demand-dependent maintenance with an authorised installer.

- ▶ Have work carried out only by an approved installer.
- ▶ If any faults are discovered, have them remedied immediately.

#### Inspection and maintenance

If there is a lack of cleaning, inspection or maintenance, or if these are carried out incorrectly, this may result in material damage and/or personal injury, including possible risk to life.

- ▶ Have work carried out only by an approved contractor.
- ▶ Do not take off the outdoor unit cover.
- ▶ Do not modify the heat pump or other parts of the heating system.

#### Room air

The air in the installation room must be free of combustible or chemically aggressive substances.

- ▶ Do not use or store combustible or explosive materials (paper, propellants, thinners, paints, etc.) within the vicinity of the appliance.
- ▶ Do not use or store corrosive substances (solvents, adhesives, chlorinated cleaning agents, etc.) within the vicinity of the appliance.

### **⚠ Damage caused by frost**

The solar system can freeze if it is switched off:

- ▶ Observe the notices regarding frost protection.
- ▶ Due to the additional functions, e.g. DHW heating or pump anti-seizure protection, the system should always be left on.
- ▶ Correct any faults immediately.

### **⚠ Risk of scalding at the DHW draw-off points**

- ▶ If DHW temperatures above 60 °C are set or if thermal disinfection is activated, a mixer must be installed. If in doubt, ask your installer.

## **2 Product description**

This is an original manual. This manual may not be translated without the approval of the manufacturer.

The Compress 3400i AWS heat pump belongs to a series of heat pumps that recover energy from the outdoor air for heating and domestic hot water heating.

By reversing this process and removing heat from the heating water and releasing it to the outdoor air, the heat pump can also be used for cooling if necessary. To do this however, the heating system must be configured for cooling mode.

In order to obtain a complete heating system, the CS3400iAWS outdoor unit which is set up outdoors must be connected to an indoor unit in the building. The indoor unit with integrated electric booster heater serves as auxiliary heater when the heat energy demand is particularly high, e.g. if the outside temperature is too low for the heat pump to operate effectively.

The heating system is controlled by the HPC 410 control unit which is located in the indoor unit. The control unit controls the system using a range of different settings for the heating, cooling, domestic hot water and other operations. The monitoring function switches the heat pump off in the event that faults occur, for example, as this prevents the main components from being damaged.

### **2.1 Control unit**

The HPC 410 control unit in the indoor unit controls the heat production based on the outdoor sensor values, possibly in combination with the room temperature-dependent controller CR10H (accessory). The temperature in the building is adapted automatically, based on the outside temperature.

The user specifies the temperature of the heating system by setting the required room temperature on the control unit or room temperature-dependent controller.

Various accessories (e.g. swimming pool, solar and room temperature-dependent controller) can be connected to the indoor unit via the EMS plus bus. Additional functions and setting options therefore become available and can also be controlled via the control unit. For more information on accessories, refer to the relevant instructions.

### **2.2 Heat pump details**

Following the installation and commissioning of the heat pump and indoor unit, specific tasks must be performed at regular intervals. These include checking whether alarms have been triggered and simple maintenance work. These actions can normally be performed by the user unassisted. However, if problems persist it may be necessary to contact the system installer.

### **2.3 Type plate**

The data plate of the outdoor unit is located on the rear side. At the indoor unit, the data plate can be found on the side cover.

It contains information on the output, part number and serial number and also the date of manufacture.

### **2.4 Declaration of Conformity**



The design and operation of this product comply with European Directives and the supplementary national requirements. Conformity has been demonstrated by the CE marking.

You can ask for a copy of the Declaration of Conformity for this product. Please refer to the contact address on the back cover of these instructions.

### **2.5 Heat pump (outdoor unit)**

The heating system consist of two parts: the heat pump outdoor unit CS3400iAWS that is installed outdoors and the indoor unit.

In a house with water based heating a difference is made between heating water and domestic hot water (DHW). The heating water is for radiators and floor coils and hot water is for showers and taps.



The outdoor unit switches off when it reaches a minimum outside temperature. The indoor unit then take over the heating and DHW heating.

For CS3400iAWS 4-10 OR-S and CS3400iAWS 10-14 OR-T the outdoor unit will switch off when the outdoor temperature is below -20 °C (approximately) or exceeds 45 °C (approximately)

For CS3400iAWS 12-14 OR-S the outdoor unit will switch off when the outdoor temperature is below -15 °C (approximately) or exceeds 45 °C (approximately)

The outdoor unit has the task of recovering energy from the outdoor air and transferring it to the indoor unit.

The outdoor unit varies the speed of the compressor automatically so that precisely the required amount of energy is supplied in each instance. The speed of the fan is also controlled and it regulates its speed according to the requirements. This keeps the energy consumption as low as possible.

### **Defrosting**

Ice can form on the evaporator at low outside temperatures. If the layer of ice becomes so thick that it impedes the flow of air through the evaporator, an automatic de-icing process is initiated. As soon as all the ice has melted, the heat pump reverts to normal mode.

At low outside temperatures, defrosting is achieved by reversing the flow direction of the refrigerant in a circuit via a 4-way valve; this type of defrosting is referred to as 'reverse circulation'.

**2.5.1 Generic overview of the refrigerant circuit**

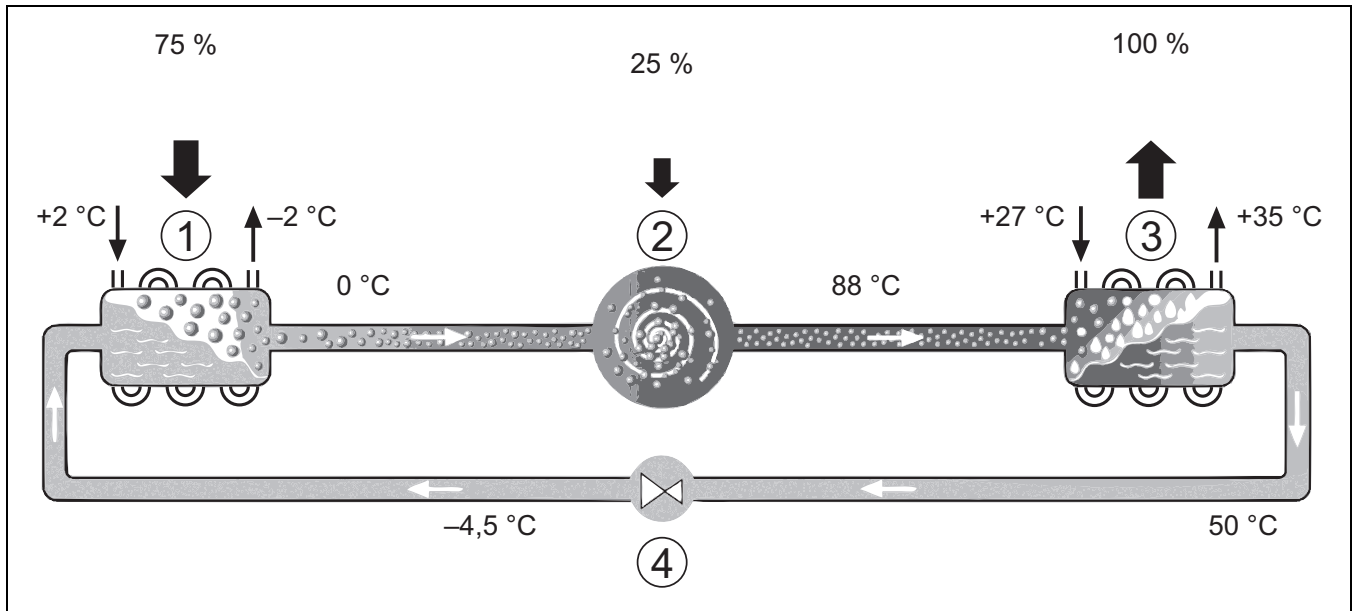

Fig. 1 Functional principle of the refrigerant circuit in the heat pump

- [1] Evaporator
- [2] Compressor
- [3] Condenser
- [4] Expansion valve

**2.6 Indoor unit**

The purpose of the indoor unit is to distribute the heat from the outdoor unit to the heating system and DHW cylinder. The speed of the circulation pump in the indoor unit is controlled so that it automatically reduces when demand is low. The energy consumption falls as a result.

If the heat energy demand is higher at low outside temperatures, an auxiliary heater may be required. Auxiliary heaters can be integrated or

external and are switched in or disconnected automatically by the user interface in the indoor unit. If the outdoor unit is in operation, the electric booster heater only produces enough heat to make up the shortfall between the outdoor unit output and the required heat. As soon as the outdoor unit is once again producing the required output on its own, the auxiliary heater is switched off automatically.

**AWSE**

When the outdoor unit is combined with the indoor unit AWS E and DHW is also to be produced via the heat pump, an external DHW cylinder must be connected. The changeover between heating and DHW is then effected by an external 3-way valve. The integrated electric booster heater in the indoor unit is started if required.

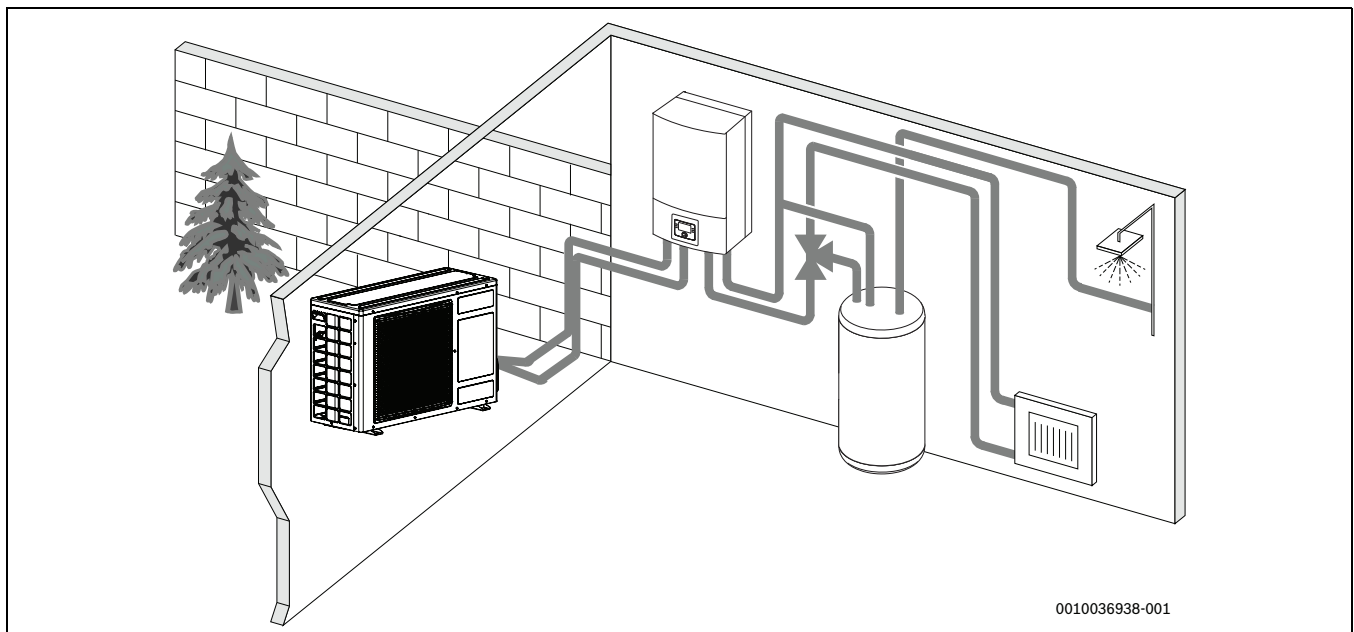

Fig. 2 Heat pump outdoor unit, indoor unit AWS E with electric booster heater and external DHW cylinder

0010036938-001

## 2.7 Hints on energy saving

- Use the normal heating mode, thus the heating system will use the least energy. Set the desired room temperature according to your personal comfort needs.
- Open the thermostatic vents fully in all rooms. Increase the temperature setting on the control only when the desired room temperature has not been reached for some time. Close the thermostatic valve in a specific room, only if that room is warmer than the others.
- If there is a room controller installed, this can be used to set the optimal room temperature. Avoid influence of external heating (i.e. sunlight or wood stove). Otherwise unwanted fluctuations in the room temperature may occur.
- Avoid placing big objects e.g. a sofa in front of the radiators (minimum 50 cm distance). This will block the circulation of the heated air in the room.
- Do not set a too low temperature for cooling. Cooling will also consume energy.

### Vent the room correctly

Open the windows fully for a short period instead of leaving them ajar. Leaving the windows ajar will let the heated air out of the room constantly without increasing the air quality. Close the thermostatic valves or lower the heating setting on the room controller while the room is vented.

## 3 Operation



### WARNING

#### Material damage from frost!

The heating or auxiliary heater may be irreparably damaged by frost.

- ▶ Do not start the indoor unit if there is a possibility of the heating or auxiliary heater being frozen.

### 3.1 Control unit

The user interface HPC 410 controls max. 4 heating circuits individually in one of the respective control modes:

- **Outdoor-temp.-compensated**
  - the flow temperature is adjusted based on the outside temperature according to an optimised heating curve.
- **Outdoor-temp.-compensated with low end<sup>1)</sup>**
  - the flow temperature is adjusted based on the outside temperature according to a simplified heating curve.

For both of the control modes a room controller may be installed in the reference room to allow the influence of the measured and required room temperature. The heating curve is then adjusted accordingly.



The user interface HPC 410 is installed in the appliance and cannot be used as room controller. Ask your contractor for available room controllers.



Rule of thumb for outdoor-temp-compensated control with influence of room temperature: the thermostatic valves in the reference room (the room in which the remote control is installed) must be fully open!



The cooling function is not available in Belgium or Denmark.



The cooling menu items mentioned in this manual may be hidden if the installed system is not suitable for cooling.



The electric booster or additional heater are not available for normal operation in Denmark. The heater is however allowed to run in fault mode, for extra DHW and thermal disinfection.

Depending on the software version of the user interface, the texts shown in the display may differ from the texts in these instructions.

The adjustment ranges, default settings and functional scope may differ from the information in these instructions, depending on the system installed at the site.

- If 2 or more heating circuits are installed, settings for different heating circuits are available and are necessary.
- If special system components and modules are installed (e.g. MS 200 solar module, pool module MP 100), corresponding settings are available and necessary.
- If certain types of heat source are installed, additional settings may be available and necessary.

#### 3.1.1 Operation after power failure

At electric power failure or periods with disconnected heat source, no settings are lost. The control unit will restart when the power is restored. It is possible that time and date may need to be reset. No other settings are needed.

#### 3.1.2 Overview of control elements and symbols

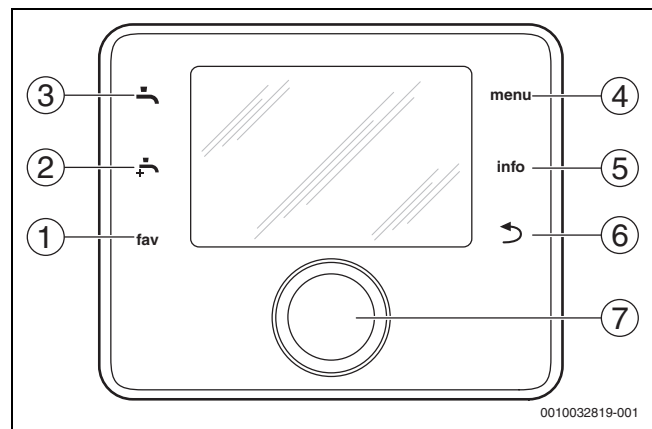

Fig. 3 Control elements

- [1] **fav** key: calls up the favourites menu
- [2] **extra DHW** key: starts extra DHW charging
- [3] **DHW** key: set the operating mode for DHW heating
- [4] **menu** key: main menu (press briefly)
- [5] **info** key: info menu or further information about the current selection
- [6] **↩** key: returns to previous menu or discards a value (press briefly); returns to the standard display (hold down)
- [7] Selector: select (turn) and confirm (press)

1) This setting is not available in Finland or Sweden





If the display lighting is off, only the lighting goes on when the selector is pressed for the first time. When the selector is turned and another control element is pressed at the same time, the lighting is switched on in addition to the effect described. The descriptions of the steps to be carried out by the operator in these instructions always assume that the lighting is activated. If no control element is actuated, the lighting turns off automatically (after approx. 30 s with the standard display, after approx. 30 min in the menu, after 24 h in the event of a fault).

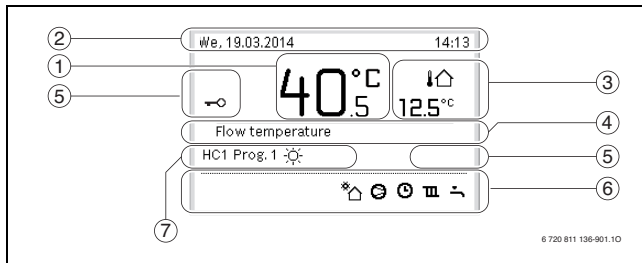

Fig. 4 Symbols in the standard display (example display)



The standard display refers only to the displayed heating circuit. Changing the required room temperature in the standard display only affects the heating circuit displayed.

Item	Symbol	Explanation
1	20.5 °C	Value display (current temperature): • Room temperature if a remote control is installed for the actual heating circuit. • Heat source temperature if there are no remote control installed.
2	-	Info line: display of time of day, day of the week and date.
3	8.0 °C	Additional temperature display: outside temperature, temperature of the solar collector or a DHW system.
		For ventilation: display of the ventilation level.
4		For ventilation: frost protection (reduced ventilation).
	-	Text information: e.g. the designation of the temperature currently displayed (→ Fig. 4, [1]). If a fault is present, corresponding information will be displayed here until the fault has been rectified.
5		The key block is active (hold down the <b>DHW</b> key and <b>selector</b> to activate or deactivate the key block).

Item	Symbol	Explanation
6		Solar circulation pump is in operation.
		DHW heating is active
		DHW thermal disinfection active
		Extra DHW active
		Pool heating active
		Heating active
		Cooling active
		Energy supplier interruption
		External input active (remote)
		Holiday mode active
		Time program active
		Smart grid function active
		Screed drying active
		Electric booster heater active
		Power guard active
		Additional heat source active
		Defrost function active
		Compressor (Heat pump) active
		An IP-module is installed and communication to the server is active.
	7	Op. mode
		Operating mode: [Program 1]   [Program 2] automatic mode active (according to time program) for displayed heating circuit.
		Operating mode: heating mode active.
		Operating mode: setback mode active.

Table 3 Symbols in the display

### 3.2 Control panel

An overview of the structure of the main menu and the position of the individual menu items can be found at the end of this document.

An overview of the items that can be found in the info menu is also found at the end of this document. The info menu is useful to get instant information of the status of the heat pump.

Each of the following descriptions takes the standard display as its starting point (→ Fig. 4).

### 3.2.1 Switching off

The user interface is powered via the BUS interface and is normally switched on. The system should only be shutdown temporarily, for example when cleaning filters. The complete system is deactivated and there is no frost protection during a shutdown.

- ▶ To temporarily switch off the system:
  - Press and hold the selector until a pop-up menu is displayed.
  - Select **Yes** in the menu **Switch to standby mode?**
- ▶ To switch on the system:
  - Press and hold the selector until a pop-up menu is displayed.
  - Select **Yes** in the menu **Switch from standby mode to normal operation?**



After a prolonged power failure or extended period of idleness, the date and time may need to be reset. All other settings are retained permanently.

### 3.2.2 Selecting a heating circuit for the standard display

The standard display only ever shows data for one heating circuit. If 2 or more heating circuits are installed, a setting can be made to determine which heating circuit the data in the standard display relates to.

- ▶ Press the selector and turn to select a heating circuit.

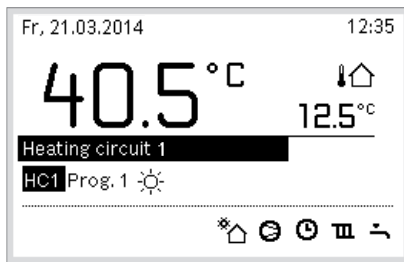

6 720 812 775-02.20

- ▶ Wait a few seconds or press the selector to confirm.

### 3.2.3 Set operating mode

#### Activate automatic mode (with time program)

If optimise operation is active:

- ▶ Press the **menu** key.
- ▶ Press the selector to open the **Heating** or **Heating/Cooling** menu.
- ▶ Press the selector to open the **Op. mode** menu.
- ▶ Highlight the desired heating circuit and press the selector.
- ▶ Choose **auto** and press the selector.
- ▶ Press and hold the ↵ key to return to the standard display.

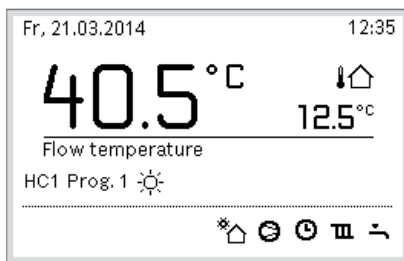

6 720 812 775-03.10

A pop-up window is displayed and the time program is activated. The currently valid temperature flashes.

#### Activating optimised operation (without time program)

If automatic mode is active:

- ▶ Press the **menu** key.
- ▶ Press the selector to open the **Heating** or **Heating/Cooling** menu.
- ▶ Press the selector to open the **Op. mode** menu.
- ▶ Highlight the desired heating circuit and press the selector.
- ▶ Choose **Optimise** and press the selector.
- ▶ Press and hold the ↵ key to return to the standard display.

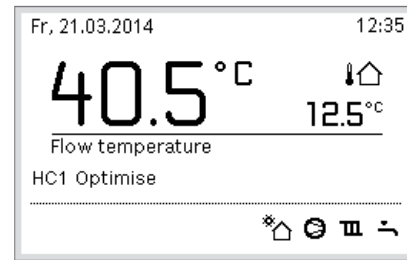

6 720 812 775-04.10

A pop-up window is displayed and the required room temperature is shown.

### 3.2.4 Changing the room temperature temporarily

#### Retaining automatic mode

- ▶ Turn and press the selector to set the required room temperature. The corresponding time slot is displayed differently to the other time slots.

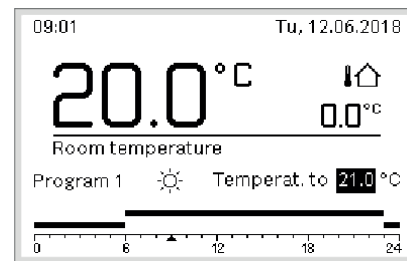

0010021418-001

The change applies until the next switching time in the active time program is reached.

Cancelling the temperature change:

- ▶ Turn and press the selector to set the value stored in the time program.

### 3.2.5 Changing the room temperature permanently

#### Optimised operation (without time program)

- ▶ Turn and press the selector to set the temperature.

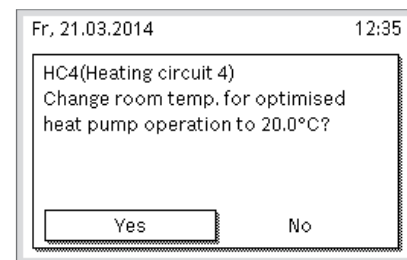

6 720 812 775-06.10

-or-

- ▶ Open the **Heating** or **Heating/Cooling** > **Temperature settings** > **Optimised operation** menu.
- ▶ Select the desired temperature and confirm or select **Heating off** and confirm.



**Automatic mode**

- ▶ Open the **Heating** or **Heating/Cooling > Temperature settings > Heating, Setback** or **Cooling** menu.

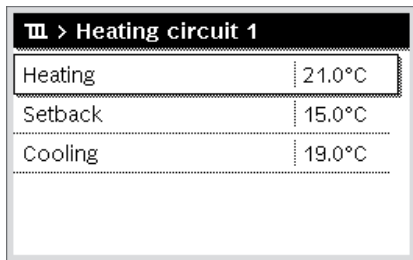

6 720 811 136-07.10

- ▶ Set the desired temperatures for each mode and confirm, or select and confirm for the **Heating off** setback mode.
- ▶ Assign the operating modes to the required time slots via the time program.

**3.2.6 Adapting the heating system settings using the time program (automatic mode)**

**Open the menu for adapting a time program for the heating system**

- ▶ Open the main menu.
- ▶ Open the menu **Heating** or **Heating/Cooling > Time program > My time program 1** or **2**.

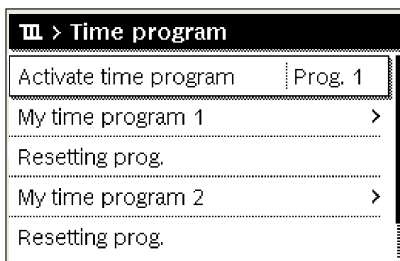

0010008191-001

**Selecting the day of the week or group of days**

- ▶ Open the menu for adapting a time program for the heating system.
- ▶ Press the selector to activate the input field for the day of the week or group of days.
- ▶ Select a day of the week or group of days and confirm.

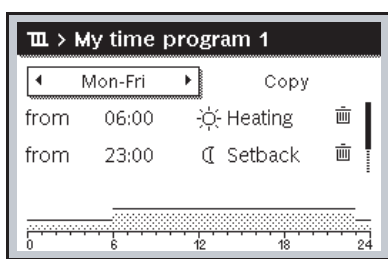

0010010088-001

**Moving switching time**

- ▶ Open the menu for adapting a time program for the heating system.
- ▶ Turn and press the selector to activate the input field for a switching time.
- ▶ Set and confirm the switching time.

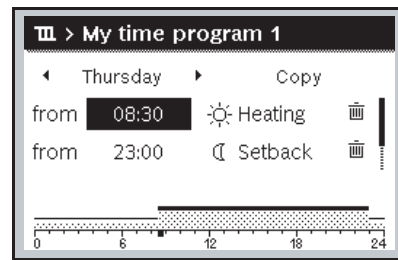

0010010089-001

**Adjusting the temperature/operating mode for a time slot**

- ▶ Open the menu for adapting a time program for the heating system.
- ▶ Turn and press the selector to activate the input field for the operating mode of a time slot.
- ▶ Set and confirm operating mode.

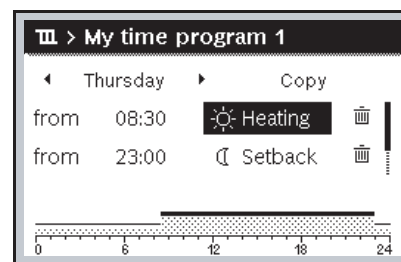

0010010090-2001

**Deleting switching time**

- ▶ Open the menu for adapting a time program for the heating system.
- ▶ Select symbol for deleting switching time (trash icon) and confirm.

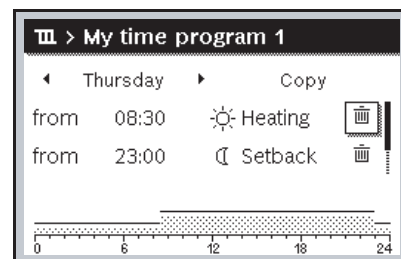

0010010093-001

- ▶ The symbol is associated with the switching time on the same line.
- ▶ Select **Yes** and confirm to delete the switching time. The previous time slot is extended to the next switching time. The switching times are automatically sorted in chronological order.

**Copying time program**

- ▶ Open the menu for adapting a time program for the heating system.
- ▶ Select the day of the week to be copied, e.g. Thursday.

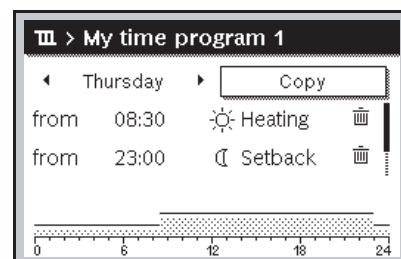

0010010094-001

- ▶ Select and confirm **Copy**.  
A pick list of the days of the week is displayed.
- ▶ Select days (e.g. Monday and Tuesday) that are to be overwritten with the previously selected time program and confirm.

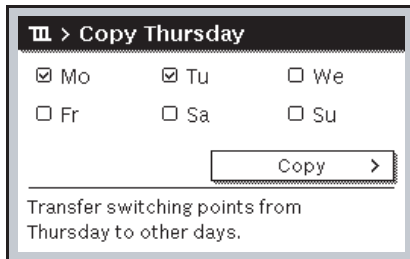

0010004419-001

- ▶ Select and confirm **Copy**.

### 3.2.7 Selecting active time program for the heating system

- ▶ Open the main menu.
- ▶ Open **Heating** or **Heating/Cooling** > **Time program** > **Activate time program**.

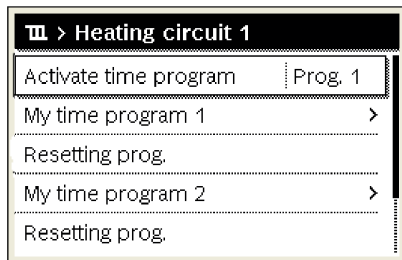

0010008189-002

- ▶ Select **My time program 1** or **2** and confirm.

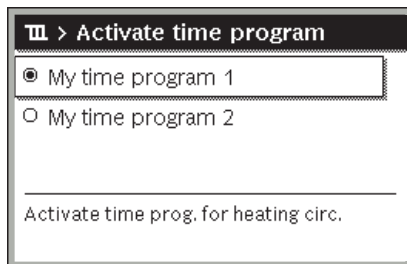

0010008190-001

The user interface operates in automatic mode with the selected time program. If 2 or more heating circuits are installed, this setting only applies for the selected heating circuit.

### 3.2.8 Renaming a time program or heating circuit

Standard designations are preassigned to the time programs and heating circuits.

#### Open the menu for renaming a time program

- ▶ Open the main menu.
- ▶ Open the **Heating** or **Heating/Cooling** > **Time program** > Heating circuit 1...4 > **Rename time prog.** menu.  
The cursor flashes to indicate the start position for data input.

#### Open the menu for renaming a heating circuit (only available if 2 or more heating circuits are installed)

- ▶ Open the main menu.
- ▶ Open **Heating** or **Heating/Cooling** > **Time program** > **Heating circuit 1** > **Rename heating circuit** menu (or other heating circuit).

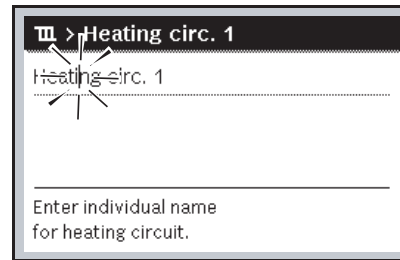

0010008233-001

The cursor flashes to indicate the start position for data input.

#### Entering/adding characters

- ▶ Open menu for renaming a time program or heating circuit.
- ▶ Turn the selector to position the cursor in the required location.
- ▶ Press the selector to activate the input field (to the right of the cursor).
- ▶ Select character and confirm.

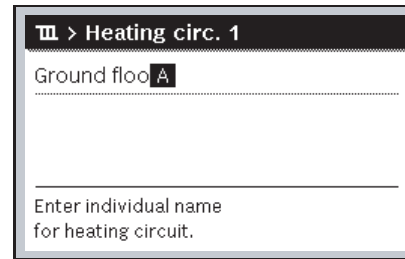

0010008199-001

The selected character is entered (added). The input field for the next character in the text is activated.

- ▶ Press the **↵** key to complete the input.

#### Deleting characters/resetting name

To delete a character:

- ▶ Open menu for renaming a time program or heating circuit.
- ▶ Place the cursor behind the character to be deleted by turning the selector.
- ▶ Press the selector to activate the input field.
- ▶ Select the character **<C** and confirm.

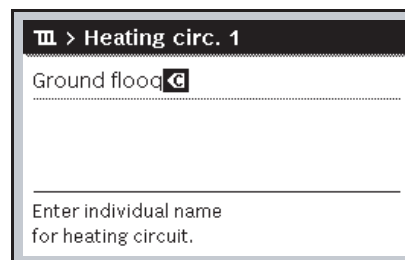

0010008200-001

The character to the left of the input field is deleted.

To reset the name:

- ▶ Delete all characters.  
The standard designation is entered again automatically.

### 3.2.9 DHW settings



When the thermal disinfection function is activated, the DHW cylinder is heated to the corresponding temperature set. The higher temperature hot water can be used for thermal disinfection of the hot water system.

- ▶ Observe regional and local requirements and operating conditions for the DHW circulation pump, including the water quality and instructions of the heat source.

#### Select the operating mode for DHW heating

Press the DHW key

- ▶ Select and confirm **Always on - DHW Eco+<sup>1)</sup>**  
Lowest DHW temperature mode that results in lowest energy consumption.
- or-
- ▶ **Always on - DHW Eco**  
Medium DHW temperature mode that results in medium energy consumption.
- or-
- ▶ **Always on - DHW comfort**  
Highest temperature mode that results in higher energy consumption and may also lead to a higher sound level from the system.

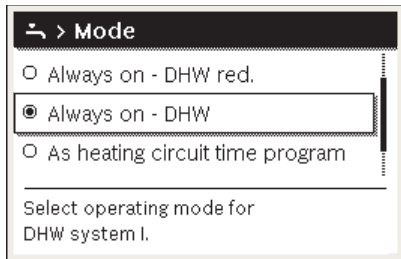

0010008204-001

The DHW temperatures for each mode is set by the installer.

#### Activate extra DHW cylinder charging

If you have a temporary need of more hot water outside of normal DHW charging or time program:

- ▶ Press the button.
- or-
- ▶ Open the menu DHW > Extra hot water.
- ▶ Set the maximum DHW temperature and duration as desired.
- ▶ Select and confirm **Start now**.

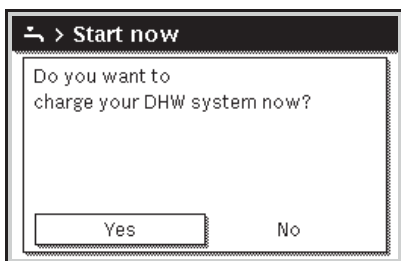

0010008184-001

- ▶ Select **Yes** in the pop-up window and confirm.
- ▶ The water heating becomes active immediately. Once the set duration time has expired, the extra DHW cylinder charging switches off again automatically.

1) Not available for fresh water station.

#### Open the menu for adapting the time program for DHW heating

- ▶ Open the main menu.
- ▶ Open the **DHW > Time program** menu.
- ▶ Select **Own time program** and confirm.
- ▶ Set switching times and operation modes.

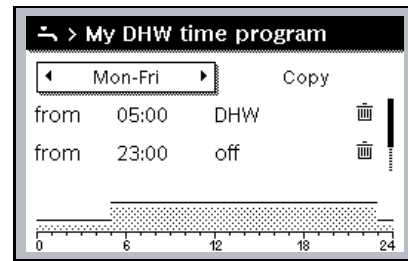

6 720 815 237-41.10

### 3.2.10 Setting up a holiday program

#### Open the menu for the holiday program

- ▶ Open the main menu.
- ▶ Open the menu **Holiday > Holiday 1, 2, 3, 4 or 5**.

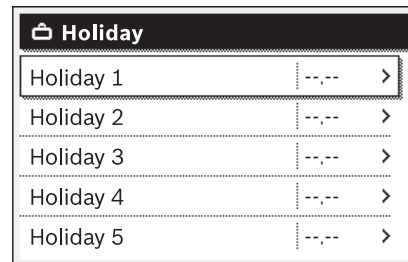

0010008208-001

Once the holiday period for the chosen holiday program has been set, the corresponding menu **Holiday 1, 2, 3, 4 or 5** is displayed.

#### Setting the holiday period

- ▶ Open the menu for the holiday program.
- ▶ If the holiday period for the chosen holiday program has already been set, open the **Holiday period** menu.
- ▶ Select and confirm the day, month and year for **Start:** and **End:** of the holiday period.

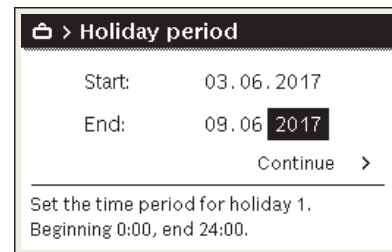

0010008209-001

- ▶ To complete the entry, select **Next** and confirm.

#### Setting the heating and DHW for the holiday program

- ▶ Open the menu for the holiday program.
- ▶ Open the **Selection of htg circ./DHW** menu.

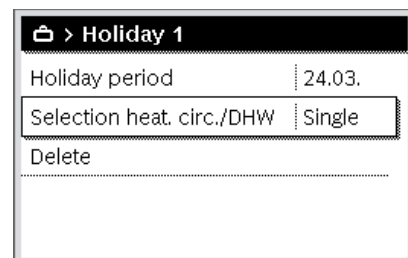

6 720 811 136-34.10

- ▶ Select and confirm the heating circuits and DHW systems.

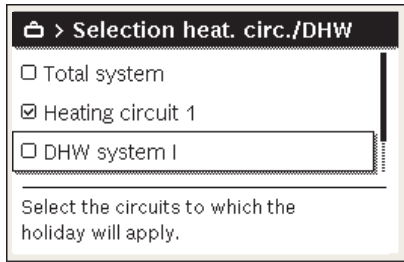

0010008211-001

- ▶ The holiday program is valid for the selected heating circuits and DHW systems.
- ▶ To complete the selection, select **Next** and confirm.
- ▶ Check the settings for **Heating** and **DHW** in the menu for the chosen holiday program, and modify if required.

### Interrupting a holiday program

During the holiday period, the display indicates until when the holiday program will be active.

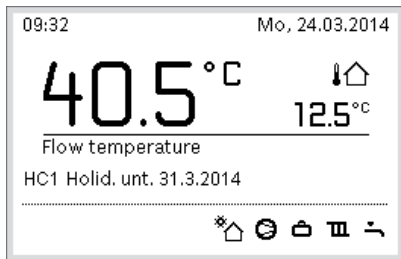

6 720 811 136-36.1O

If 2 or more heating circuits are installed, the relevant heating circuit must be selected in the standard display before interrupting the holiday program.

If the holiday program is set to **As Saturday**:

- ▶ Turn the selector and set the desired temperature. The change applies until the next switching time in the active time program is reached.

If no time program is active the holiday program is interrupted by deleting it.

### Clearing a holiday program

- ▶ Open the menu for the holiday program.
- ▶ Select and confirm **Delete**.
- ▶ Select **Yes** in the pop-up window and confirm.

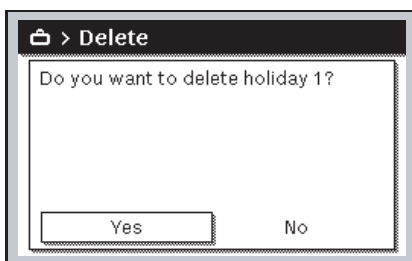

0010008212-001

The holiday program is deleted.

### 3.2.11 More settings

#### Setting the time and date

If the user interface has been disconnected from the power supply for a prolonged period, the date and time must be set:

- ▶ Restore the power supply. The user interface displays the setting for the date.

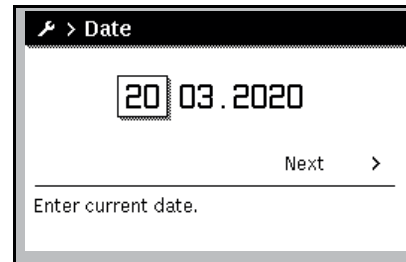

0010003250.002

- ▶ Set the day, month and year respectively and confirm.
- ▶ Confirm **Next**. The user interface displays the setting for the time.

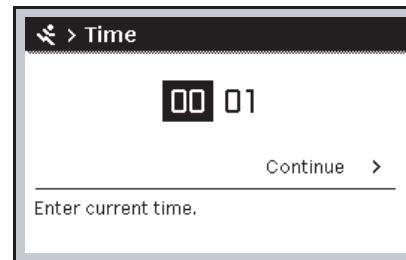

0010003251.001

- ▶ Set the hours and minutes respectively and confirm.
- ▶ Confirm **Next**. No other settings are required for recommissioning.

#### Switching the key block on/off

To switch the key block on or off:

- ▶ Press the **selector** and **DHW** key simultaneously until the key symbol in the display appears/disappears.

#### Setting up the favourite functions

The **fav** key gives direct access to often used functions for heating circuit 1. Press the key once to open the menu.

To adapt the list of favourites in the menu:

- ▶ Press and hold the **fav** key until the configuration menu is displayed.
- ▶ Turn and press the selector to select a function (**Yes**) or to cancel the selection (**No**).
- ▶ Press the **↵** key to close the menu.

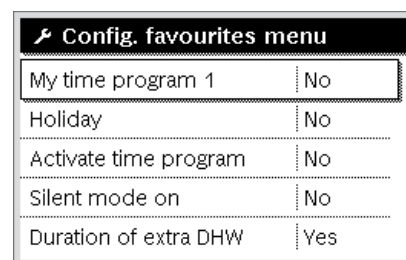

6 720 811 136-15.1O

### 3.3 Main menu

Depending on the heating appliance and how the user interface is used, not all menu items will be available for selection; see overview of main menu at the end of this document.

#### 3.3.1 Heating settings

Menu: **Heating**

Menu item	Description
Op. mode	Select the heating operating mode: optimised or based on time program.
Temperature settings	Temperatures for the levels [Heating], [Setback] or [Optimised operation] can be set in this menu.
Time program	→ see Tab. 5
Summer/winter changeover	→ see Tab. 6
DHW alternating operation	→ see Tab. 7

Table 4 Heating settings

#### Adapting the Time program for the automatic mode

Menu: **Time program**

Menu item	Description
Activate time program	Activating automatic mode triggers control of the room temperature according to the settings in the selected time program [My time program 1] or [My time program 2].
My time program 1	2 switching times can be set for each day or group of days. One of the two operating modes (or a temperature) can be assigned to each switching time in automatic mode. The minimum duration of a time slot between two switching times is 15 minutes.
Resetting prog.	The default setting for [My time program 1] can be restored here.
My time program 2	→ See [My time program 1]
Resetting prog.	The default setting for [My time program 2] can be restored here.
Rename time prog.	The names of the time programs can be changed in the same way as the names of the heating circuits. This helps to select the correct time program, e.g. "family" or "night shift".

Table 5 Time program settings for heating

#### Setting the summer/winter switchover threshold



#### CAUTION

#### Risk of system damage!

- ▶ Do not switch over to summer mode if there is a risk of frost.

Menu: **Summer/winter changeover**

Menu item	Description
Heating/Cooling	<ul style="list-style-type: none"> <li>In summer, heating/cooling mode can be switched off [Continuous summer].</li> <li>The heating/cooling mode can be activated/shut down based on the outside temperature (this is only available if the [Automatic mode] is active in the heating circuit).</li> <li>The heating mode can be active [Continuous heating]. However, heating starts only if it is too cold inside.</li> <li>The cooling mode can be active [Cooling]. However, cooling starts only if it is too hot inside.</li> </ul> <p>If more than one heating circuit is installed, [Heating circuit 1 ... 4] is displayed instead of this menu item.</p>
Heating mode from <sup>1)</sup>	If the outside temperature <sup>2)</sup> falls below the temperature threshold set here, the heating system is switched on. In systems with more than one heating circuit, this setting always relates to the corresponding heating circuit in each case.
Cooling mode from	If the outside temperature exceeds the temperature threshold set here, the heating system is switched off and cooling is enabled. In systems with more than one heating circuit, this setting always relates to the corresponding heating circuit in each case.

- 1) This menu item is only displayed if the outdoor-temperature-dependent switching between summer and winter modes is active for the heating circuit concerned.
- 2) When the outside temperature is adjusted (damped), changes to the measured outside temperature are delayed and fluctuations reduced.

Table 6 Settings for the summer/winter changeover

#### Setting the DHW alternating operation

If DHW alternating operation is not activated, DHW heating has priority and interrupts the heat requirement of the heating system, if necessary.

Menu: **DHW alternating operation**

Menu item	Description
DHW alt. operation on	In the event of simultaneous DHW and heating demand, the system will alternate between DHW heating and heating mode based on the times set in [Prioritise DHW for] and [Heating priority for].
Prioritise DHW for	Duration of DHW heating.
Heating priority for	Duration of heating mode.

Table 7 Settings for the DHW alternating operation

#### 3.3.2 DHW settings



Using the extra DHW, thermal disinfection or daily heat up functions can lead to higher electricity cost as the electric booster heater may be activated.



If a fresh water station is installed, setting the DHW temperature  $\geq 52\text{ }^\circ\text{C}$  can lead to higher electricity cost as the electric booster heater may be activated.

### Setting the operation mode for DHW heating

The installer sets the temperatures for the different modes.

Menu: Op. mode

Menu item	Description
Op. mode	<ul style="list-style-type: none"> <li>• [Off]: Deactivated, no DHW production.</li> <li>• [Always on - DHW Eco+]<sup>1)</sup>: Lowest DHW temperature mode that results in lowest energy consumption.</li> <li>• [Always on - DHW Eco]: Medium DHW temperature mode that results in medium energy consumption.</li> <li>• [Always on - DHW comfort]: Highest temperature mode that results in higher energy consumption.</li> <li>• [Own time program]: DHW time program that operates independently of any heating circuit time program.</li> </ul>

1) Not available for fresh water station

Table 8 Settings for operation mode of DHW

### Setting the time program for DHW heating

Menu: Time program

Menu item	Description
My DHW time prog.	Own time program for DHW heating that works independently of the time program for the heating system. 6 switching times can be set for each day or group of days. One of the operating modes can be assigned to each switching time in automatic mode. The minimum duration of a time slot between two switching times is 15 minutes.
Resetting prog.	The time program for the DHW system is reset to the default setting with this menu item.

Table 9 Time program settings for DHW

### Activating extra DHW heating

Menu: Extra hot water

Menu item	Description
Start now/ Cancel now	After activation of the extra hot water function, DHW is heated for the set duration to the set temperature. When the function is active, [Cancel now] is displayed in the menu. Select this setting for immediate deactivation of the extra hot water function.
Temperature	Desired DHW temperature for the extra hot water function.
Duration	Duration for the extra hot water function. When the time has expired, the function automatically switches off and the system goes back to normal DHW operation.

Table 10 Settings for the extra hot water function

### Thermal disinfection



#### WARNING

#### Danger to life from legionella!

Legionella can form in domestic hot water at DHW temperatures that are too low.

- ▶ Activate thermal disinfection
- or-
- ▶ Have daily heat-up set in the service menu by the specialist technician.
- ▶ Thermal disinfection may be terminated prematurely due to the system configuration or frequent water extraction. In this case the control unit issues a fault display. When thermal disinfection is activated, attention must be paid to ensuring, that this is performed successfully without a fault display.
- ▶ Observe the statutory regulations on drinking water.



If the thermal disinfection has terminated prematurely a notification is shown in the display. The system will repeat the thermal disinfection 24 hours later.



If the thermal disinfection is set and activated at an external heat source, the settings at the user interface have no effect on the thermal disinfection.



#### WARNING

#### Risk of scalding!

If thermal disinfection or the daily heat-up has been activated to avoid legionella, the DHW is heated once to above 60 °C (e.g. Tuesday night at 02:00).

- ▶ Only carry out thermal disinfection/daily heat-up outside the normal hours of use.
- ▶ Make sure that a mixer is installed. If in doubt, ask your expert.

Menu: Autom. therm. disinfect.

Menu item	Description
Start	The entire DHW volume is automatically heated to the set temperature once a week or daily, if [Auto] is set here.
Start now/ Cancel now	Immediate start or cancellation of thermal disinfection independently of the set day of the week.
Weekday	Day of the week, on which thermal disinfection is automatically carried out once a week, or daily thermal disinfection.
Time of Day	Time of day for the automatic start of thermal disinfection.

Table 11 Settings for thermal disinfection



### Setting the DHW alternating operation

If DHW alternating operation is not activated, DHW heating has priority and interrupts the heat requirement of the heating system, if necessary.

Menu: **DHW alternating operation**

Menu item	Description
DHW alt. operation on	In the event of simultaneous DHW and heating demand, the system will alternate between DHW heating and heating mode based on the times set in [Prioritise DHW for] and [Heating priority for].
Prioritise DHW for	Duration of DHW heating.
Heating priority for	Duration of heating mode.

Table 12 Settings for the DHW alternating operation

### Settings for the DHW circulation

Menu: **Circulation**

Menu item	Description
Op. mode	<ul style="list-style-type: none"> <li>[Off]: Circulation is switched off permanently.</li> <li>[On]: The pump will run according to the settings under [Start frequency]. The time program for the DHW circulation pump is not active.</li> <li>The circulation can be linked to the time program for DHW heating.</li> <li>[My circulation time prog.]: Set a time program for the DHW circulation pump that works independently of the time program for DHW.</li> </ul>
Start frequency	The start frequency determines how often the DHW circulation pump goes into operation for three minutes at a time every hour (1 x 3 minutes/h ... 6 x 3 minutes/h) or if it is constantly in operation. Whatever the case, circulation is only active during the times set in the time program.
My circulation time prog.	6 switching times can be set for each day or group of days. The DHW circulation pump can be switched on or off at each switching time. The minimum duration of a time slot between two switching times is 15 minutes.
Resetting prog.	The time program is reset to factory default.

Table 13 Settings for the circulation

### 3.3.3 Settings for the venting function

Menu: **Ventilation**

Menu item	Description
Op. mode	[Select vent. operating mode.] <ul style="list-style-type: none"> <li>[Sleep]</li> <li>[High vent. rate] (high ventilation rate)</li> <li>[Auto (time program)]</li> <li>[Demand-ctrlled] (demand controlled)</li> <li>[Ex.air bypass] (exhaust air bypass)</li> <li>[Party vent.] (party ventilation)</li> <li>[Firepl.] (fireplace)</li> <li>[Fan speed 1 ... 4]</li> <li>[Ventil. switched off] (ventilation off)</li> </ul>
Time program	[Enter vent. time program.]
Reset time prog.	[Reset ventilation time program.]
Humidity	[Setting the desired humidity level]: <ul style="list-style-type: none"> <li>[Dry]</li> <li>[Normal]</li> <li>[Moist]</li> </ul>

Menu item	Description
Air quality	[Setting the desired air quality level]: <ul style="list-style-type: none"> <li>[Adequate]</li> <li>[Normal]</li> <li>[High]</li> </ul>
Bypass	[Bypass] for more opening hours: <ul style="list-style-type: none"> <li>[Open]</li> <li>[Close.]</li> </ul>
Supply air temp. control	Set the [Supply air temp.]: <ul style="list-style-type: none"> <li>[Heating]</li> <li>[HtgCool] (heating and cooling)</li> <li>[Cooling]</li> <li>[Off]</li> </ul>
Supply air temp. control (Electric)	Set the [Supply air temp.]: <ul style="list-style-type: none"> <li>[Heating]</li> <li>[Off]</li> </ul>
Reheat supp.air temp.	[Set the desired supply air temp. of reh. bank.] 10 ... <b>22</b> ... 30 °C
Filter timer	[Set the time in months until the next filter change.] 1 ... <b>6</b> ... 12 Months
Confirm filter change	The filters in the ventilation unit must be changed. Please confirm the filter change.
Rename ventil. zone	The names of the ventilation zones can be changed in the same way as the names of the heating circuits. This helps in choosing the right ventilation zone.

Table 14 Ventilation settings

### Settings for a swimming pool

Menu: **Pool**

Menu item	Description
Switch on pool heating	This setting enables the pool heating when it is activated.
Pool temperature	The water in the pool is heated to this temperature.
Allow add. heater for pool	This setting allows the auxiliary heater to supply heating for the pool if the heat pump cannot reach the set temperature.

Table 15 Settings for pool heating

### 3.3.4 Setting up a holiday program

Menu: **Holiday**



#### Risk of system damage!

- ▶ Before a prolonged period of absence, only change the settings under **Holiday**.
- ▶ After a long absence, check the operating pressure of the heating system and check the pressure gauge of the solar system if applicable.
- ▶ Do not switch off the solar system during long absences.



Cooling mode will not be activated during a holiday program.

Menu: **Holiday 1, Holiday 2, Holiday 3, Holiday 4 and Holiday 5**

Menu item	Description
Holiday period	Set the start and end date of the absence during holiday: the holiday program starts at the set start time at 00:00 o'clock. The holiday program ends at the set end time at 24:00 o'clock.
Selection of htg circ./DHW	The holiday program is applied to the sections of the system highlighted here. Only the heating circuits and DHW systems actually installed in the system are available for selection.
Heating	Control of the room temperature for the selected heating circuits during the holiday period: <ul style="list-style-type: none"> <li>• Any [Constant temperature] can be set for the selected heating circuits throughout the entire holiday period.</li> <li>• The [Off] setting deactivates the heating system completely for the selected heating circuits.</li> </ul>
DHW	DHW settings for the selected DHW systems during the holiday period. <ul style="list-style-type: none"> <li>• If [Off] is set, no DHW at all will be available during the holiday period.</li> <li>• If [Off + therm. disinfection on] is set, DHW heating is deactivated but thermal disinfection is still carried out as normal either once a week or once a day.</li> </ul> Note: If the holiday is spent at home, the DHW systems must not be selected under [Selection of htg circ./DHW] to ensure DHW remains available.
Delete	Delete all settings for the selected holiday program

Table 16 Settings for holiday programs

#### Settings for smart grid

This menu is only available if a smart grid system is installed.

If smart grid energy is available and a buffer cylinder is installed with all heating circuits mixed, the buffer cylinder will be heated to the heat pump maximum temperature.

Menu item	Control range: Function description
Heating	The energy available in the smart grid is used for heating, if the system is in heating mode. [Selectable peak]: 0...5 °C Set how much the room temperature may be increased. [Forced peak]: 2...5 °C Set how much the room temperature is forced to increase.

Menu item	Control range: Function description
DHW	The energy available in the smart grid is used for DHW. [Selectable peak]: [Yes]   [No] If enabled the DHW is heated to the temperature set for DHW operating mode [Always on - DHW comfort]. No heating is done if the holiday program is active.

Table 17 Settings in the smart grid data menu

#### Settings for a photovoltaic system

Make the photovoltaic (PV) specific settings in this menu. Select if the available energy should be used for **Heating** or **DHW**.

If photovoltaic energy is available and a buffer cylinder is installed with all heating circuits mixed, the buffer cylinder will be heated to the heat pump maximum temperature.

Menu: **PV system**

Menu item	Control range: Function description
Heating peak	The energy available in the PV system is used for heating, if the system is in heating mode. Set how much the room temperature may be increased [0...5] K.
DHW peak	The energy available in the PV system is used for DHW. [Yes]   [No] If enabled the DHW is heated to the temperature set for DHW operating mode [Always on - DHW comfort]. No heating is done if the holiday program is active.
Cooling setback mode	The energy available in the PV system is used for cooling, if the system is in cooling mode. Set how much the room temperature may be decreased [-5...0] K.

Table 18 Settings in the PV system data menu

#### Settings for the energy manager

Make the energy manger (EM) specific settings in this menu.

Menu: **Energy manager**

Menu item	Control range: Function description
Heating peak	The energy available in the energy management system is used for heating, if the system is in heating mode. Set how much the room temperature may be increased 0...5 °C.
Only cool with EM	Cooling mode is activated only if energy is available in the energy management system. [Yes]   [No] If enabled the room temperature is decreased to the temperature set for cooling operating mode. No cooling is done if the holiday program is active.

Table 19 Settings in the EM system data menu

### 3.3.5 General Settings

Menu: **Settings**

Menu item	Description
Language	Language of the display texts
Time format	Switch the format for display of the time of day between 24-hour and 12-hour format.
Time of Day	Set actual time. All time programs and thermal disinfection run according to this time.
Date format	Change the format of the date.
Date	Set actual date. The holiday program, for example, runs based on this date. The current day of the week is also determined based on this date; this affects the time programs and thermal disinfection, for example.

Menu item	Description
Auto. time switchover	Activate or deactivate the automatic changeover between summer and winter time. If [Yes] is set, the time of day is automatically changed (from 02:00 to 03:00 on the last Sunday in March and from 03:00 to 02:00 on the last Sunday in October).
Display contrast	Change the contrast (for improved clarity).
Warning sound blocked	If a buzzer has been installed a warning sound is emitted as soon as an alarm occurs. The warning sound can be suppressed at a settable time interval.
Reduced DHW temp.	Setting for the reduced DHW mode. If [Yes] is set, the DHW temperature is reduced if there are a compressor fault. The function is used to reduce the use of the auxiliary heater.
DHW temp. correction	Correction of the DHW temperature displayed by the user interface by up to $\pm 10$ °C. The function is used for a more accurate representation of the DHW tap temperature as the temperature sensor is positioned at a distance from the DHW outlet.
Time correction	Time correction of the internal clock of the user interface in s/week.
Standard display	Settings for the display of additional temperatures in the standard display.
Internet password	Reset the personal password for the Internet connection (only available if a communication module is installed). The next time you log in, e.g. using an App, you will automatically be prompted to assign a new password.
Internet	Make settings for the Internet connection (only available if a communication module is installed). <ul style="list-style-type: none"> <li>• [Establish connection]                             <ul style="list-style-type: none"> <li>– [Pairing-Status]</li> <li>– [Activate hotspot]</li> <li>– [Activate WPS]</li> </ul> </li> <li>• [Terminate connection]                             <ul style="list-style-type: none"> <li>– [Connected network]</li> <li>– [Terminate connection]</li> </ul> </li> </ul>
Low-noise operation	If activated the heat pump will run in reduced sound operation during the set time period. <ul style="list-style-type: none"> <li>• [Low-noise operation of]: set the start time for the low noise operation.</li> <li>• [Low-noise operation until]: set the stop time for the low noise operation.</li> <li>• [Min. outside temp.]: Below this outdoor temperature the heat pump switches over to normal operation.</li> </ul>
Reset	Reset all settings to the values set at commissioning.

Table 20 General Settings

### 3.3.6 Settings for other systems or devices

If other specific systems or devices are installed in the system, additional menu items will be available. Depending on which system or device is being used and the associated assemblies or components, various settings can be made. Observe the additional information on the settings and functions in the technical documentation for the relevant system or device.

### 3.4 Calling up information about the system

The current system values and the active operating conditions can be displayed easily via the info menu. No changes can be made in this menu.

To open the info menu:

- Press the **info** key in the standard display.

Menu: Sum./winter changeover

Menu item	Description
Heating/cooling mode	Currently valid operating mode in the selected heating circuit.
Set room temp.	The desired room temperature that is currently valid in the selected heating circuit: <ul style="list-style-type: none"> <li>• In automatic mode, this can change several times a day, if necessary.</li> <li>• In normal operation, it is always constant.</li> </ul>
Measured room temp.	Currently measured room temperature in the selected heating circuit
Measured flow temp.	Currently measured flow temperature in the selected heating circuit

Table 21 Information about the heating

Menu: DHW

Menu item	Description
Set temp.	Desired DHW temperature.
Measured temp.	Currently measured DHW temperature.

Table 22 Information about DHW

Menu: **Ventilation**

Menu item	Description
Op. mode	Currently selected operating mode and ventilation level
Outside temperature	Display of Outside temperature
Supply air temp.	Display of supply air temperature
Ex.air temp.	Display of extract air temperature
Exhaust air temp.	Display of exhaust air temperature
Reheat supp.air temp.	Display of supply air temperature from the re-heater
Ex.air humid.	Display of exhaust air humidity
Ex.air quality	Display of exhaust air quality
Humidity remote ctrl	Display of humidity in the installation room of the remote control
Amb. air humid.	Display of ambient air humidity
Amb. air quality	Display of ambient air quality
Bypass	Display of bypass-settings
Rem. filter elapsed	Display of duration in days until the next filter change time

Table 23 Information about the ventilation unit

Menu: **Pool**

Menu item	Description
Set pool temperature	Desired pool temperature.
Current pool temperature	Currently measured pool temperature.

Table 24 Information about pool

Menu: **Operating data**

Menu item	Description
Control operating hours	Hours run by the control since the heat pump was commissioned or since the last reset.
Aux. heater energy cons.	Output of the electric booster heater since commissioning or since the last reset.
Op. hours for comp. heat.	Hours run by the compressor in heating mode since commissioning or since the last reset.

Menu item	Description
Op. hours for comp. cool.	Hours run by the compressor in cooling mode since commissioning or since the last reset.
Op. hours for comp. DHW	Hours run by the compressor in DHW operation since commissioning or since the last reset.
Op. hours for comp. pool	Hours run by the compressor in pool operation since commissioning or since the last reset.
Number of heating starts	Number of compressor starts in heating mode since commissioning or since the last reset.
Number of cooling starts	Number of compressor starts in cooling mode since commissioning or since the last reset.
Number of DHW starts	Number of compressor starts in DHW operation since commissioning or since the last reset.
Number of pool starts	Number of compressor starts in pool operation since commissioning or since the last reset.

Table 25 Operation data

Menu: **Energy consump.**

Menu item	Description
Total	Cumulated total energy consumed by the heating system.

Table 26 Total energy consumption data

Menu: **Energy consump.** > **Electric auxiliary heater**

Menu item	Description
Total	Cumulated total energy consumed by the electric booster heater.
Heating	Cumulated energy consumed by the electric booster heater in heating mode.
DHW	Cumulated energy consumed by the electric booster heater in DHW mode.
Pool	Cumulated energy consumed by the electric booster heater in pool heating mode.

Table 27 Energy consumption data for electric booster heater

Menu: **Energy consump.** > **Compressor**

Menu item	Description
Total	Cumulated total energy consumed by the heat pump.
Heating	Cumulated energy consumed by the heat pump in heating mode.
DHW	Cumulated energy consumed by the heat pump in DHW mode.
Cooling	Cumulated energy consumed by the heat pump in cooling mode.
Pool	Cumulated energy consumed by the heat pump in pool heating mode.

Table 28 Energy consumption data for heat pump

Menu: **Energy supplied**

Menu item	Description
Total energy suppl.	Cumulated total energy output of the heat pump.
Heating energy suppl.	Cumulated energy output of the heat pump in heating mode.
DHW energy suppl.	Cumulated energy output of the heat pump in DHW mode.
Emitted cooling energy	Cumulated energy output of the heat pump in cooling mode.
Pool energy suppl.	Cumulated energy output of the heat pump in pool heating mode.

Table 29 Energy output data for heat pump

Menu: **Solar**

Menu item	Description
Solar sensor (graphic)	Current measured temperatures with display of position of the selected temperature sensor in the solar system hydraulics (with graphic visualisation of the current operating conditions of the actuators in the solar system).
Solar yield	Solar yield for last week, solar yield for current week and total yield of solar system since the solar system was commissioned.

Table 30 Information about the solar system

Menu: **Outdoor temp**

The currently measured outside temperature is displayed in this menu. In addition, a diagram of the outside temperature profile for today and yesterday (from 00:00 to 24:00 in each case) is displayed here.

Menu: **Internet**

Menu item	Description
IP connection	Status of the connection between communication module and router.
Server connection	Status of the connection between communication module and Internet (via the router).
Connected network	Status of the connection between communication module and the network and display of WLAN-SSID.
IP address	IPV4 address of the communication module.
SW version	Software version of the communication module.
Login data	Login name and password for the login into the App to operate the system via a smartphone.
MAC address	MAC address of the communication module.

Table 31 Information about the Internet connection

### 3.5 Faults

**If a fault persists:**

- ▶ Confirm the fault by pressing the selector.
- ▶ Faults that are still active are displayed by pressing the ↵ key.
- ▶ Call an authorised contractor or customer service and give them the fault code and sub-code, as well as the ID no. of the user interface.



Table 32 Your contractor must enter the ID no. here.

Faults on additional heat source:

- ▶ Check the display of the additional heat source for information.
- ▶ Reset the additional heat source.
- ▶ If the fault persists; contact your contractor.

### 3.6 Connect-Key K 30 RF

Connect-Key K 30 RF is a WLAN communication module for controlling and monitoring your heating system remotely. It is used as an interface between the heating system and the Internet.

For further information on how to use and install the Connect-Key K 30 RF, please read the installation manual of the accessory.



A WLAN router, internet connection and the **Bosch HomeCom Easy** app are required to use this product.

## 4 Maintenance



### Risk of electric shock.

Grave personal injuries may occur.

- ▶ Disconnect the power supply before carrying out maintenance work.



Using the wrong cleaning product may damage the units!

- ▶ Do not use acid or chlorine based products or products that contain abrasives.

### 4.1 Indoor unit

Check the following points a couple of times a year:

- ▶ Checking the operating pressure
- ▶ Overheating protection
- ▶ Particle filter
- ▶ Moisture in cooling mode
- ▶ Safety valves

#### 4.1.1 Checking the operating pressure



The pressure should be checked 1-2 times per year.

- ▶ Check the pressure at the pressure gauge.
- ▶ If the pressure is less than 0.5 bar, increase the pressure slowly to max. 2 bar by filling with water via the fill valve.
- ▶ If you have any questions about the procedure, consult the installer of the system.

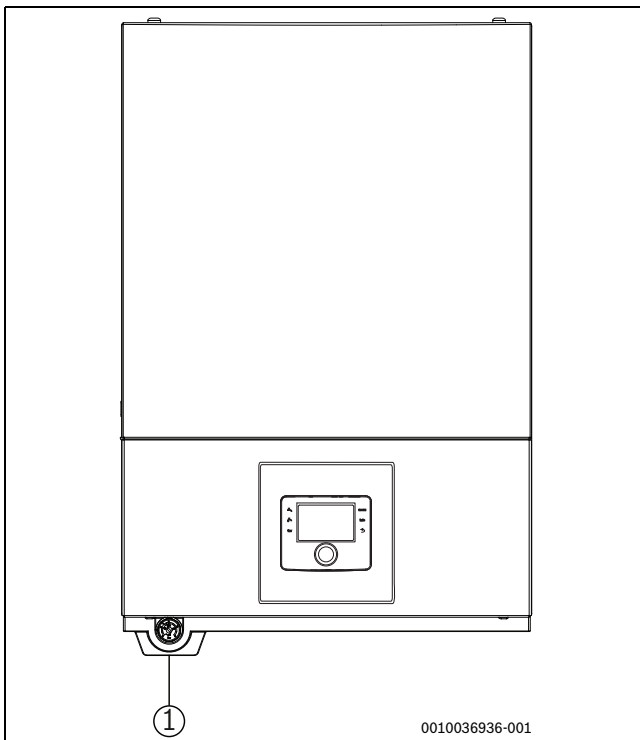

Fig. 5 AWS E indoor unit (view with drip tray)

[1] Pressure gauge

#### 4.1.2 Overheating protection



Overheating protection is only available in indoor units with integrated booster heater. The overheating protection has to be manually reset if it is triggered.

To reset the overheating protection on AWS E :

- ▶ Contact the installer or dealer.

#### 4.1.3 Particle filter



### WARNING

#### Strong magnet!

Can be harmful to pacemaker wearers.

- ▶ Do not clean the filter or check the magnetite indicator if you are a pacemaker wearer.

The filter prevents particles and contamination from entering the heat pump. Over time, the filter may become blocked and must be cleaned.



The system does not need to be emptied to clean the filter. The filter is integrated into the shut-off valve.

#### Cleaning the strainer

- ▶ Close the valve (1).
- ▶ Unscrew the cap (manually) (2).
- ▶ Take out the strainer and clean it with running water over it or by pressure cleaning.
- ▶ Check attached debris on the cap's magnet (3) and clean it.
- ▶ Reinstall the strainer (4). For proper assembly, make sure that the guide bumps fit into the recesses in the valve.
- ▶ Screw the cap back on (hand tight).
- ▶ Open the valve (5).

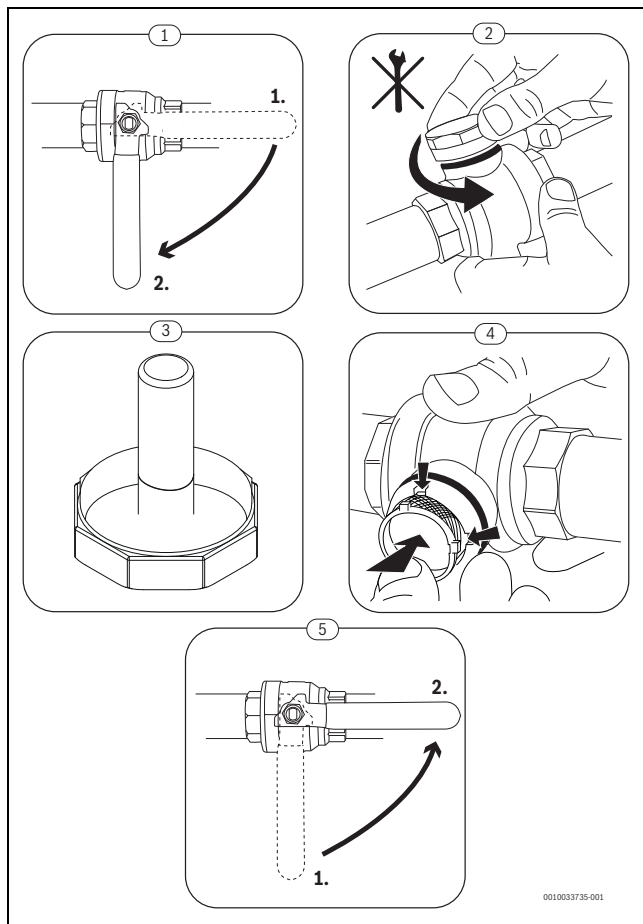

Fig. 6 Cleaning the strainer

#### 4.1.4 Moisture in cooling mode

##### NOTICE

If moisture frequently forms near the indoor unit or the fan convectors in cooling mode, this could mean that the condensation insulation is defective.

- ▶ If moisture forms in the vicinity of components of the heating system, switch the heat pump off and consult the system installer.

#### 4.1.5 Checking the safety valves



The safety valves should be checked 1-2 times each a year.



Water is expelled from the safety valve during heat-up. Never close the safety valve.

- ▶ The safety valve should only let water out if the maximum pressure is exceeded. Contact the installer if water is coming from the safety valve at pressures below 2 bar.
- ▶ The drainage hose from the safety valve shall be discharged into the drainage.

#### 4.2 Heat pump (outdoor unit)

The following inspection and maintenance steps are carried out several times per year in order that the heat pump's maximum output will be maintained:

- ▶ Removing dirt and leaves
- ▶ Casing

- ▶ Evaporator
- ▶ Snow and ice

##### DANGER

##### Risk of electric shock.

- ▶ Always de-energize the electrical connection before carrying out maintenance work on the device (fuse, circuit breaker).



Damage to system due to use of unsuitable cleaning agents!

- ▶ Do not use acidic or alkaline cleaning agents or cleaning agents containing chlorine or abrasive products.
- ▶ Do not use strong alkaline cleaning agents, e.g. sodium hydroxide.

#### 4.2.1 Removing dirt and leaves

- ▶ Remove dirt and leaves with a brush.

#### 4.2.2 Casing

Dust and other dirt particles concentrate in the heat pump's outdoor unit over time.

- ▶ If required, clean the outside with a damp cloth.
- ▶ Spot repair cracks and damage on the casing with anti-corrosive paint.
- ▶ Standard car wax can be applied to protect the paint.

#### 4.2.3 Evaporator

Wash off any layers of e.g. dust or dirt deposited on the surface of the evaporator.

##### WARNING

The thin aluminium fins are sensitive and can be damaged easily through incorrect handling. Never dry the fins directly with a cloth.

- ▶ Wear protective gloves during cleaning to protect your hands from cuts.
- ▶ Never use high water pressure.

Cleaning the evaporator:

- ▶ Spray detergent on the evaporator fins on the back of the heat pump.
- ▶ Rinse all coatings and cleaning agents off completely with water.

#### 4.2.4 Snow and ice

In certain geographical regions or during periods of heavy snow, snow can get stuck on the back and the top of the heat pump. To prevent subsequent formation of ice, remove the snow.

- ▶ Clear the snow off the top.
- ▶ Hot water can be used to rinse off the ice.

Moisture can form under the CS3400iAWS outdoor unit due to condensate not falling into the condensation catch pan. This is normal and no special action is required.

#### 4.3 Tightness test

Under the current EU Directives (F-Gas Regulation, EC Regulation No. 517/2014, which entered into force on 1 January 2015), operators of equipment containing fluorinated greenhouse gases in an amount of five tonnes or more of CO<sub>2</sub> equivalent that are not part of foams must ensure that the equipment is checked for leaks.

The tightness test must be carried out during installation and then every 12 months.

- ▶ Consult an installer.



#### 4.4 Information on refrigerant

This device **contains fluorinated greenhouse gases** as a refrigerant. The following information on the refrigerant complies with the requirements of EU Regulation No. 517/2014 on fluorinated greenhouse gases.



Notice for the user: If your installer adds refrigerant, he enters the added fill volume and the total amount of the refrigerant in the following table.

Unit designation	Refrigerant type	Global warming potential (GWP) [kgCO <sub>2</sub> eq]	CO <sub>2</sub> equivalent of the original fill volume [t]	Original fill volume [kg]	Added fill volume [kg]	Total amount on commissioning [kg]
CS3400iAWS 4 OR-S	R32	675	0.743	1.100		
CS3400iAWS 6 OR-S	R32	675	0.878	1.300		
CS3400iAWS 8 OR-S	R32	675	0.878	1.300		
CS3400iAWS 10 OR-S	R32	675	0.878	1.300		
CS3400iAWS 12 OR-S	R410A	2088	6.682	3.200		
CS3400iAWS 14 OR-S	R410A	2088	6.682	3.200		
CS3400iAWS 10 OR-T	R410A	2088	6.682	3.200		
CS3400iAWS 12 OR-T	R410A	2088	6.682	3.200		
CS3400iAWS 14 OR-T	R410A	2088	6.682	3.200		

Table 33 Information on refrigerant

### 5 Environmental protection and disposal

Environmental protection is one of the fundamental company policies of the Bosch Group.

We regard quality of products, economy and environmental protection as equal objectives. Environmental protection laws and regulations are strictly adhered to.

To protect the environment, we use the best possible technology and materials taking economic aspects into account.

#### Packaging

Where packaging is concerned, we participate in country-specific recycling processes that ensure optimum recycling.

All of our packaging materials are environmentally compatible and can be recycled.

#### Used appliances

Used appliances contain valuable materials that can be recycled.

The various assemblies can be easily dismantled. Synthetic materials are marked accordingly. Assemblies can therefore be sorted by composition and passed on for recycling or disposal.

#### Old electrical and electronic appliances



This symbol means that the product must not be disposed of with other waste, and instead must be taken to the waste collection points for treatment, collection, recycling and disposal.

The symbol is valid in countries where waste electrical and electronic equipment regulations apply, e.g. "(UK) Waste Electrical and Electronic Equipment Regulations 2013 (as amended)". These regulations define the framework for the return and recycling of old electronic appliances that apply in each country.

As electronic devices may contain hazardous substances, it needs to be recycled responsibly in order to minimize any potential harm to the

environment and human health. Furthermore, recycling of electronic scrap helps preserve natural resources.

For additional information on the environmentally compatible disposal of old electrical and electronic appliances, please contact the relevant local authorities, your household waste disposal service or the retailer where you purchased the product.

You can find more information here:  
[www.weee.bosch-thermotechnology.com/](http://www.weee.bosch-thermotechnology.com/)

### 6 Data Protection Notice



We, **Bosch Thermotechnology Ltd., Cotswold Way, Warndon, Worcester WR4 9SW, United Kingdom** process product and installation information, technical and connection data, communication data, product registration and client history data to provide product functionality (art. 6 (1) sentence 1 (b) GDPR / UK GDPR), to fulfil our duty of product surveillance and for product safety and security reasons (art. 6 (1) sentence 1 (f) GDPR / UK GDPR), to safeguard our rights in connection with warranty and product registration questions (art. 6 (1) sentence 1 (f) GDPR / UK GDPR) and to analyze the distribution of our products and to provide individualized information and offers related to the product (art. 6 (1) sentence 1 (f) GDPR / UK GDPR). To provide services such as sales and marketing services, contract management, payment handling, programming, data hosting and hotline services we can commission and transfer data to external service providers and/or Bosch affiliated enterprises. In some cases, but only if appropriate data protection is ensured, personal data might be transferred to recipients located outside of the European Economic Area and the United Kingdom. Further information are provided on request. You can contact our Data Protection Officer under: Data Protection Officer, Information Security and Privacy (C/ISP), Robert Bosch GmbH, Postfach 30 02 20, 70442 Stuttgart, GERMANY.

You have the right to object, on grounds relating to your particular situation or where personal data are processed for direct marketing purposes, at any time to processing of your personal data which is based on art. 6 (1) sentence 1 (f) GDPR / UK GDPR. To exercise your rights, please contact us via [privacy.ttg@bosch.com](mailto:privacy.ttg@bosch.com). To find further information, please follow the QR-Code.

## 7 Display of consumption values in relation to the funding guidelines for federal funding for efficient buildings - individual measures (BEG EM)

The displayed energy consumption, heat quantities and device efficiency (hereinafter "consumption values") are calculated from device-specific data and measured values. The consumption values displayed are only an estimate (interpolation).

In real operation, many different factors influence energy consumption. The specific consumption values are among others influenced by:

- Installation / execution of the heating system,
- user behaviour,
- seasonal environmental conditions,
- components used.

The consumption values displayed relate exclusively to the heating appliance. Consumption values of other components of the entire heating system (complete heating system with all its associated components), such as i.e. external heating circulation pumps or valves are not taken into account. The deviations between the displayed and the actual consumption values can therefore be considerable in real operation.

The representation of the consumption values enables the operator to make a relative comparison of the energy consumption over time. In addition, excess or reduced consumption can also be determined. A use for binding billing purposes is not possible.

## 8 Technical terms

### CS3400iAWS outdoor unit

The central heat source. Installed in the open air. Alternative designation: outdoor unit. Contains the entire refrigerant circuit except for the condenser. Gaseous refrigerant is routed to the indoor unit from the CS3400iAWS outdoor unit.

### Indoor unit

Installed in the building and distributes the heat from the heat pump to the heating system and DHW cylinder. Contains the control unit and primary pump to the heating system. The refrigerant is condensed in the condenser and fed back to the CS3400iAWS outdoor unit.

### Heating installation

Designation for the entire installation, comprising the heat pump, heat pump module, DHW cylinder, heating system and accessories.

### Heating system

Comprises the heat source, container, radiators, underfloor heating system or fan convectors or a combination of these elements if the heating system is made up of several heating circuits.

### Heat. circ.

The part of the heating system that distributes the heat throughout the various rooms. Consists of pipework, pump and radiators, heating hoses of the underfloor heating system or fan convectors. Only one of the specified alternatives is possible within a circuit. However, if for example the heating system is equipped with two circuits, radiators can be installed in one and an underfloor heating system installed in the other. Heating circuits can be configured with and without mixers.

### Heating water/domestic hot water

If domestic hot water is connected to the system, a distinction is made between heating water and domestic hot water. The heating water is channeled to the radiators and the underfloor heating system. Shower and water taps are supplied with domestic hot water.

If a DHW cylinder is present in the system, the control unit switches between heating and DHW mode so that maximum comfort is achieved. The DHW or heating mode can be prioritised by selecting an option on the control unit.

### Heating circuit without mixer

In a heating circuit without mixer the temperature in the circuit is controlled purely by the energy from the heat source.

### Heating circuit with mixer

In a heating circuit with mixer, the mixer mixes return water from the circuit with water from the heat pump. This allows heating circuits with mixer to be operated at a lower temperature than the other heating system, e.g. so that underfloor heating systems that operate at lower temperatures can be separated from radiators that require higher temperatures.

### Mixer

The mixer is a valve that steadily mixes colder return water with hot water from the heat source in order to achieve a specific temperature. The mixer can be situated in a heating circuit or in the heat pump module for the external auxiliary heater.

### 3-way valve

The 3-way valve distributes thermal energy to the heating circuits or the DHW cylinder. It has two defined settings so that heating and DHW heating cannot occur at the same time. This is also the most effective operating mode, as the DHW is always heated to a specific temperature, while the heating water temperature is continuously adjusted to the outdoor air temperature in each case.

### Heat transfer medium circuit

The part of the heating system that transports the heat from the outdoor unit to the indoor unit.

### Cooling circuit

The main part of the outdoor unit that obtains energy from the outdoor air and transfers this as heat to the heat transfer medium circuit. Consists of evaporator, compressor, condenser and expansion valve. The refrigerant circulates in the cooling circuit.

### Evaporator

Heat exchanger between air and refrigerant. The energy from the air that is drawn in through the evaporator causes the refrigerant to boil and turn to gas as a result.

### Compressor

Moves the refrigerant through the cooling circuit from the evaporator to the condenser. Increases the pressure of the gaseous refrigerant. The temperature also increases as the pressure increases.

### Condenser

Heat exchanger between refrigerant in the cooling circuit and water in the heat transfer medium circuit. During the heat transfer, the temperature of the refrigerant falls as it changes into the liquid aggregation state.

### Expansion valve

Reduces the pressure of the refrigerant after it is discharged from the condenser. The refrigerant is then channeled back to the evaporator where the process starts again.

### Inverter

Located in the outdoor unit and enables the speed of the compressor to be controlled based on the heat energy demand in each case.



### Setback phase

A period during the time-controlled operation involving the **setback** operating mode.

### Time-controlled operation

The heating system is heated in accordance with the time program and switching between the operating modes occurs automatically.

### Operating phase

The heating operating phases are: **heating** and **setback**. They are depicted by the symbols  and .

The operating phases for DHW heating are: **Comfort**, **Eco** and **Eco+**. A temperature can be set for each operating phase (except for **Off**).

### Frost protection

Depending on the type of frost protection selected, the outdoor unit is switched on if the outside temperature or room temperature falls below a certain critical threshold. Frost protection prevents the heating system from freezing up.

### Desired room temperature

The room temperature to be achieved by the heating system. It can be set individually.

### Default settings

Values saved permanently on the control unit, which are available at all times and can be reset as necessary.

### Heating phase

A period during the time-controlled operation involving the **heating** operating mode.

### Parental lock

Settings in the standard display and in the menu can only be changed if the parental lock (key block) is switched off.

### Mixer/mixing valve

Assembly that automatically ensures that DHW can be drawn from the draw-off points at a temperature no higher than the temperature set on the mixing valve.

### Normal Operation

In normal mode, automatic mode (the heating system time program) is not active and the home is steadily heated at the temperature set for normal mode.

### Reference room

The room in your home where the remote control is installed is the reference room. The room temperature in this room acts as the control variable for the assigned heating circuit (which can include several rooms or the entire house if only one circuit is present).

### Switching time

A particular time when the heating temperature, for example, is increased or reduced. A switching time is a component of a time program.

### Temperature during an operating phase

A temperature that is assigned to an operating phase. The temperature is adjustable. Refer to the explanations about the operating mode.

### Flow temperature

The temperature that the heating water in the heating circuit retains from the heat source through to the radiators or the underfloor heating system in the room.

### Hot water cylinder

A DHW cylinder stores large volumes of heated potable water. Sufficient hot water is available at the draw-off points (e.g. water taps) as a result.

### Time program for heating

This time program ensures automatic switchover between the operating phases at defined switching times.

## 9 Overview Main menu

This is an overview of all possible menu items. In each installation only menus of installed modules or components are shown.

### Heating or Heating/Cooling

- Op. mode
- Temperature settings
  - Heating
  - Setback
  - Optimised operation
  - Cooling
- Time program
  - Activate time program
  - My time program 1
  - Resetting prog.
  - My time program 2
  - Resetting prog.
  - Rename time prog.
- Summer/winter changeover
  - Heating
  - Summer mode from
  - Op. mode
  - Cooling mode from
- DHW alternating operation
  - DHW alt. operation on
  - Prioritise DHW for
  - Heating priority for

### DHW

- Op. mode
- Time program
  - My DHW time prog.
  - Resetting prog.
- Extra hot water
  - Start now
  - Cancel now
  - Temperature
  - Duration
- Autom. therm. disinfect.
  - Start
  - Start now
  - Cancel now
  - Temperature
  - Weekday
  - Time of Day
- DHW alternating operation
  - DHW alt. operation on
  - Prioritise DHW for
  - Heating priority for
- Circulation
  - Op. mode
  - Start frequency
  - My circulation time prog. (circulation time program)
  - Resetting prog. (reset circulation time program)

---

**Ventilation**

---

- Op. mode
- Time program
- Reset time prog.
- Humidity
- Air quality
- Bypass
- Supply air temp. control
- Reheat supp.air temp. (After-heater supply air temperature)
- Filter timer
- Confirm filter change
- Rename ventil. zone

---

**Pool**

---

- Switch on pool heating
- Pool temperature
- Allow add. heater for pool

---

**Holiday**

---



---

**Smart grid**

---

- Heating
  - Selectable peak
  - Forced peak
- DHW
  - Selectable peak

---

**PV system**

---

- Heating peak
- DHW peak
- Cooling setback mode

---

**Energy manager**

---

- Heating peak
- Only cool with EM

---

**Settings**

---

- Language
- Time format
- Time of Day
- Date format
- Date [DD.MM]
- Auto. time switchover
- Display contrast
- Warning sound blocked
  - Warning sound blocked
  - Warn. sound blocked by
  - Warn. snd. blocked until
- Reduced DHW temp.
- DHW temp. correction
- Time correction
- Standard display
- Internet password
- Internet
  - Establish connection
  - Terminate connection
- Low-noise operation

- Low-noise operation
  - Low-noise operation of
  - Low-noise operation until
  - Min. outside temp.
  - Reset
    - Reset settings
- 

---

**10 Overview Info**

---

This is an overview of all possible information. In each installation only information of installed modules or components are shown.

---



---

**Heating or Heating/Cooling**

---

- Heating/cooling mode
  - Set room temp. (set room temperature)
  - Measured room temp. (measured room temperature)
  - Measured flow temp. (measured flow temperature)
- 

---

**DHW**

---

- Set temp. (set DHW temperature)
  - Measured temp. (measured DHW temperature)
- 

---

**DHW (Fresh water station)**

---



---

**Ventilation**

---

- Op. mode
  - Outside temperature
  - Supply air temp.
  - Ex.air temp.
  - Exhaust air temp.
  - Reheat supp.air temp. (Reheater supply air temperature)
  - Ex.air humid.
  - Ex.air quality
  - Humidity remote ctrl
  - Amb. air humid.
  - Amb. air quality
  - Bypass
  - Rem. filter elapsed time
- 

---

**Pool**

---

- Set pool temperature
  - Current pool temperature
- 

---

**Operating data**

---

- Control operating hours
  - Aux. heater energy cons.
  - Op. hours for comp. heat.
  - Op. hours for comp. cool.
  - Op. hours for comp. DHW
  - Op. hours for comp. pool
  - Number of heating starts
  - Number of cooling starts
  - Number of DHW starts
  - Number of pool starts
- 

---

**Energy consump.**

---

- Total

- Electric auxiliary heater
    - Total
    - Heating
    - DHW
    - Pool
  - Compressor
    - Total
    - Heating
    - DHW
    - Cooling
    - Pool
  - 24h: ventil. current
  - 30d: ventil. current
- 
- Add. heat source
  - Mixing valve
  - El. DHW additional heater
  - ESC block
  - PV system
  - Smart grid
  - Current operation
  - COP heat source
- 

### Energy supplied

---

- Total energy suppl.
  - Heating energy suppl.
  - DHW energy suppl.
  - Emitted cooling energy
  - Pool energy suppl.
- 

### Solar

---

- Solar sensor
  - Solar yield
- 

### Outdoor temp

---

- Outside temp. curve
  - Outdoor temp
  - Wireless outside temp.
- 

### Internet

---

- IP connection
  - Server connection
  - Connected network
  - IP address
  - SW version
  - Login data
  - MAC address
- 

### System information (Only active limitations are shown, otherwise the menu is empty)

---

- Heat pump status
  - Compressor off. Too cold
  - Comp. off. Too warm
  - Max. air intake temp.
  - Min. air intake temp.
  - Cool. mode off. Too cold
  - Cool. mode off. Too warm
  - Max. temp. reached
  - Heat p. off: Low fl. temp.
  - Warm-up phase
  - Max. add. heater temp.
  - Anti-seizure mode
  - Insuff. DHW flow rate
- Cooling circuit status
- Compressor output
- Additional heater status
- Elec. boost. heater output
- Status aux heater with mix







Bosch Thermotechnik GmbH  
Junkersstrasse 20-24  
73249 Wernau, Germany  
[www.bosch-thermotechnology.com](http://www.bosch-thermotechnology.com)

GB Importer:  
Bosch Thermotechnology Ltd.  
Cotswold Way, Warndon  
Worcester WR4 9SW, United Kingdom